

OWNER'S INSTALLATION AND OPERATION INSTRUCTION BOOK

Blaze® King

WOOD STOVES

BLAZE KING® CATALYST STOVE
King Model KEJ-1101

BLAZE KING® CATALYST STOVE
Princess Model PEJ-1002

OM-09C-CANADA

10/16/85

RCR

Revised Nov. 16/85

SAVE THESE INSTRUCTIONS

BLAZE KING WOOD STOVES

Blaze King Catalyst stove, KING model KEJ-1101
Blaze King Catalyst stove, PRINCESS model PEJ-1002

The latest additions to the Blaze King Royal Family

SAFETY NOTICE: If this Blaze King stove is not properly installed, a house fire may result. For your safety, follow the installation directions. Contact local building or fire officials about restrictions and installation inspection requirements in your area.

INSTALLATION AND OPERATION INSTRUCTIONS

You are now the proud owner of a Blaze King Catalyst stove - the cleanest, most efficient wood stove in North America.

It is the desire of the manufacturer that your stove give you a lifetime of trouble-free operation. Therefore, we suggest that before starting installation, you read these installation and operation instructions.

WARRANTY

To register your warranty, fill out and return the 'Warranty Card' packed with these instructions in the firebox of the stove.

Improper installation of your Blaze King Catalyst stove or failure to operate it according to the guidelines detailed in these instructions may negate your warranty and endanger your home and family.

IMPORTANT: While every effort has been made to make these instructions as complete as possible, some installation or operating conditions may not be covered. If you have questions not answered here, contact your Blaze King dealer or your local building or fire inspector.

Blaze King Catalyst Stove
Figure 1

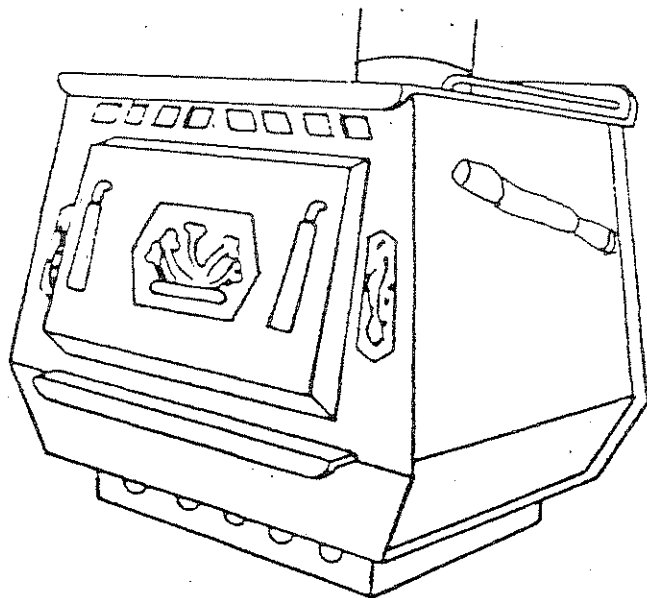

Table 1. SPECIFICATIONS SUMMARY

MODEL	W.	D.	H.	Approximate Base Dimension	WT.	Minimum Floor Protection	Side	Back	Corner
KEJ-1101	32	32	33	20-3/8x17	436	42 x 52	16"	6"	10"
KEJS-1101	32	32	33	20-3/8x17	451	42 x 52	9"	6"	5"
PEJ-1002	29	31.5	29	18-3/8x16-1/2	344	39 x 51	16"	6"	10"
PEJS-1002	29	31.5	29	18-3/8x16-1/2	357	39 x 51	9"	6"	5"
PEJ-1002(MH)	29	31.5	29	18-3/8x16-1/2	344	39 x 51	20"	6"	8"
PEJS-1002(MH)	29	31.5	29	18-3/8x16-1/2	357	39 x 51	10"	5"	4"

PRODUCT INSPECTION

First, remove all packaged parts from your stove and inspect them. Make sure that the stove is complete. Examine the pieces to see that there is no damage caused by shipping. Should any part be missing or damaged, contact your dealer.

CHECK LIST

1. Stove with firebrick installed.
2. Door(s) with gasket material installed.
3. Wood Handles.
4. Thermostat knob.
5. Top Rails and nuts
(or push-on nuts and bowed washers)
6. Ceramic Rings and screws.
7. Ceramics (Fig. 2)
8. Catalytic Combustor.

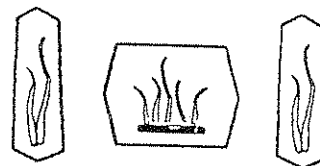

Ceramics
Figure 2.

SOME CAUTIONS:

1. Stove must be vented ONLY to the outside, not to other rooms or buildings.
2. NEVER use a chimney or chimney connector smaller than the 8" (7" for PEJ-1002) stove exhaust.
3. NEVER vent your woodburning stove into a "Class B" (Gas Vent) chimney. Check with local authorities to make sure that you are not inadvertently using a "Class B" chimney.
4. Burn natural wood ONLY. Burning materials other than natural wood will appreciably shorten the life of the Catalytic Combustor. DO NOT burn trash, garbage, artificial or paper logs, gift wrappings, coal, lighter fluids, chemical cleaners, chemical starters, treated or painted wood, driftwood, or foil-backed paper such as gum wrappers or cigarette packages.
5. For proper, safe installation use factory built components only. The use of make-shift components is not allowed.
6. Installation clearances may only be reduced by means approved by the regulatory authority.

BUILDING CODES AND PERMITS

Some areas may require a permit from the city, county, Building Inspector, or Fire Marshal. Check local building codes before beginning installation. After the installation is completed, it should be checked by your local Fire Marshal or Building Inspector.

SELECTION OF STOVE LOCATION

Warnock Hersey Professional Services, Ltd. listed this appliance only to be connected to a suitable masonry chimney, or an 8" (7" for PEJ-1002) Listed Residential Type and Building Heating Appliance Type (hereafter referred to as Prefabricated chimney in this instruction) chimney system; and minimum clearances to combustibles are observed. See CHIMNEY and CHIMNEY CONNECTORS, and Figures 10-15 for minimum clearances.

WARNING: DO NOT cut ceiling or roof joists without maintaining the structural support of the dwelling. DO check floor joists for proper support of the stove.

For MOBILE HOME INSTALLATIONS:

WARNING: DO NOT INSTALL IN SLEEPING ROOM.

CAUTION: The structural integrity of the mobile home floor, wall and ceiling/roof must be maintained.

NOTICE: Models PEJ-1002 and PEJS-1002 only, were tested and listed for mobile home installations utilizing a prefabricated chimney system, straight up from the stove top, through the ceiling and roof. Under no conditions are elbows and/or tees permitted in mobile homes. Refer to Table 2.

CHIMNEYS

DO NOT CONNECT THIS UNIT TO A CHIMNEY FLUE SERVING ANOTHER APPLIANCE.

Generally, the taller the chimney, the stronger, more dependable the draft. The chimney should be kept warm to enhance the draft. This will also protect against creosote accumulation caused by condensation of water vapor and smoke. A build-up of creosote can reduce the draft and will become a potential fire hazard. See CREOSOTE.

A chimney should extend at least three feet above a flat roof, or at least two feet above any part of the roof within 10 feet. Chimney tops should NEVER be near trees or other tall objects that might cause down-drafts.

Freestanding wood stoves can only be vented into existing chimneys or into a listed, 8" (7" for PEJ-1002), low heat, prefabricated, metal chimney system (listed by Warnock Hersey Professional Services, Ltd. or other approved laboratory). installed through the ceiling. Horizontal installations are not allowed. The use of chimney components other than those listed in Table 2, is not allowed.

When using an existing chimney - or after installing a prefabricated chimney - determine the draft, using a water manometer. The draft should be held between .02" and .06" of water.

This appliance may not operate properly if the draft is outside the above limits. Draft below .02" will cause excessive smoke spillage, incomplete combustion and fire startup problems. Continuous use above .06", may cause catalytic failure.

WARNING: CONSISTENT USE OF DRAFTS HIGHER THAN .06" MAY NEGATE YOUR CATALYTIC COMBUSTOR WARRANTY.

EXISTING CHIMNEY

Before installation of any wood burning unit to an existing chimney, take care that the chimney is sound. There should be no cracks or holes. The cross sectional area must not be less than that of the 8" (7" for PEJ-1002) flue collar. Relining or rebuilding may be necessary to make the chimney safe and efficient and bring it into conformity with local codes. A proper chimney is most important for safe, satisfactory operation of any wood heating system.

PREFABRICATED CHIMNEY

There are two major types of prefabricated chimney pipe. Solid pack insulated and air cooled or not insulated. Insulated stove pipe and air cooled stove pipe are Listed as Residential Type and Building Heating Appliance Type chimney (referred to as Prefabricated chimney in this instruction).

Prefabricated chimney is available from numerous manufacturers. Consult local building codes and fire codes to determine which type of pipe may be safely installed. Ask your local dealer about the availability of types of pipe which meet local codes. Only Commander 650 Chimney manufactured by James A. Ryder or Security S-2100 Chimney manufactured by Security Chimney (Canada) Ltd. may be used for Mobile Home installations. See Table 2 for listed chimney systems.

Special methods are required when passing through a wall or ceiling. See chimney manufacturer's instructions and local building codes. Be sure to maintain the vapor barrier at the roof or external wall exit.

CHIMNEY CONNECTORS

The stove collar accepts only 8" (7" for PEJ-1002) pipe. The small end of the pipe fits into the collar to enable any distillates which may form in the chimney to fall back into the stove.

Generally speaking, heavy-duty 8" (7" for PEJ-1002) single wall, blue or black steel pipe (not less than 24-gauge) is used to connect the stove to a masonry or prefabricated chimney. (Prefabricated chimney is not normally required as a chimney connector for residential installations.) Only a Listed Ryder Connector or Security Double Wall Connector, model D.P., may be used in Mobile Home installations.

A chimney connector can also be used horizontally as a connection between the stove and masonry chimneys or Prefabricated chimneys, provided that the length does not exceed three (3) feet AND THE PIPE SLOPES UPWARD TOWARD THE CHIMNEY AT A RATE OF 1/4" PER FOOT. This slope in the horizontal connection is required to facilitate the drainage of creosote deposits back into the stove (see Fig. 5 & 6). The chimney connector is to be attached to the smoke collar with two screws.

Chimney connectors shall not pass through an attic or roof space, closet or similar concealed space, or a floor, ceiling, wall, or partition of combustible construction. Maintain at least 18" (480 mm) to combustibles.

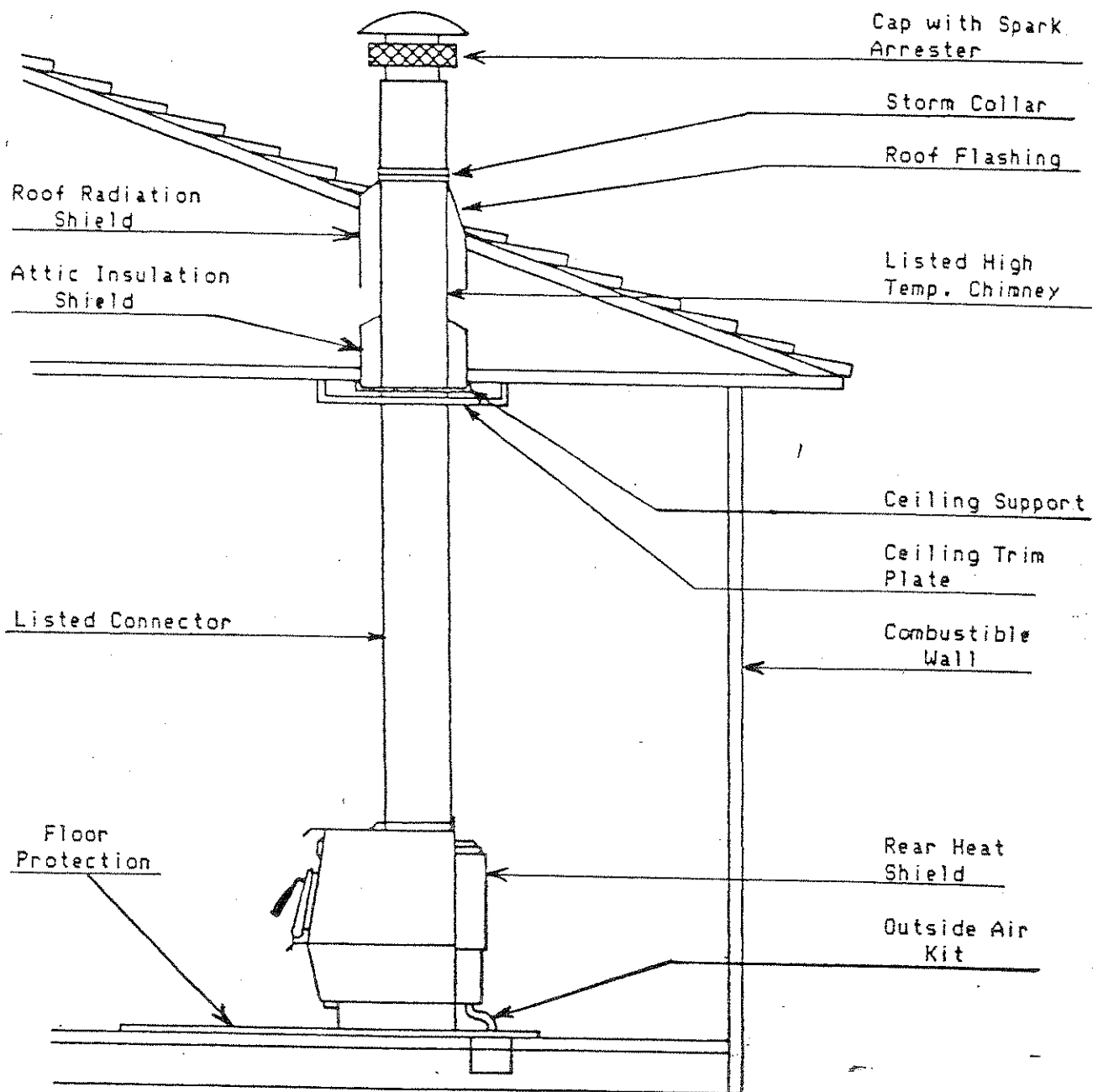

Figure 3. Mobile Home Installation. Refer to Table 2.

Table 2. Pipe for MOBILE HOME INSTALLATIONS. Refer to Figure 3.

(1) Mobile Home Chimney Component Kit supplied by Security Chimney, Ltd.

(2) Mobile Home Chimney Component Kit supplied by James A. Ryder Mfg., Ltd.

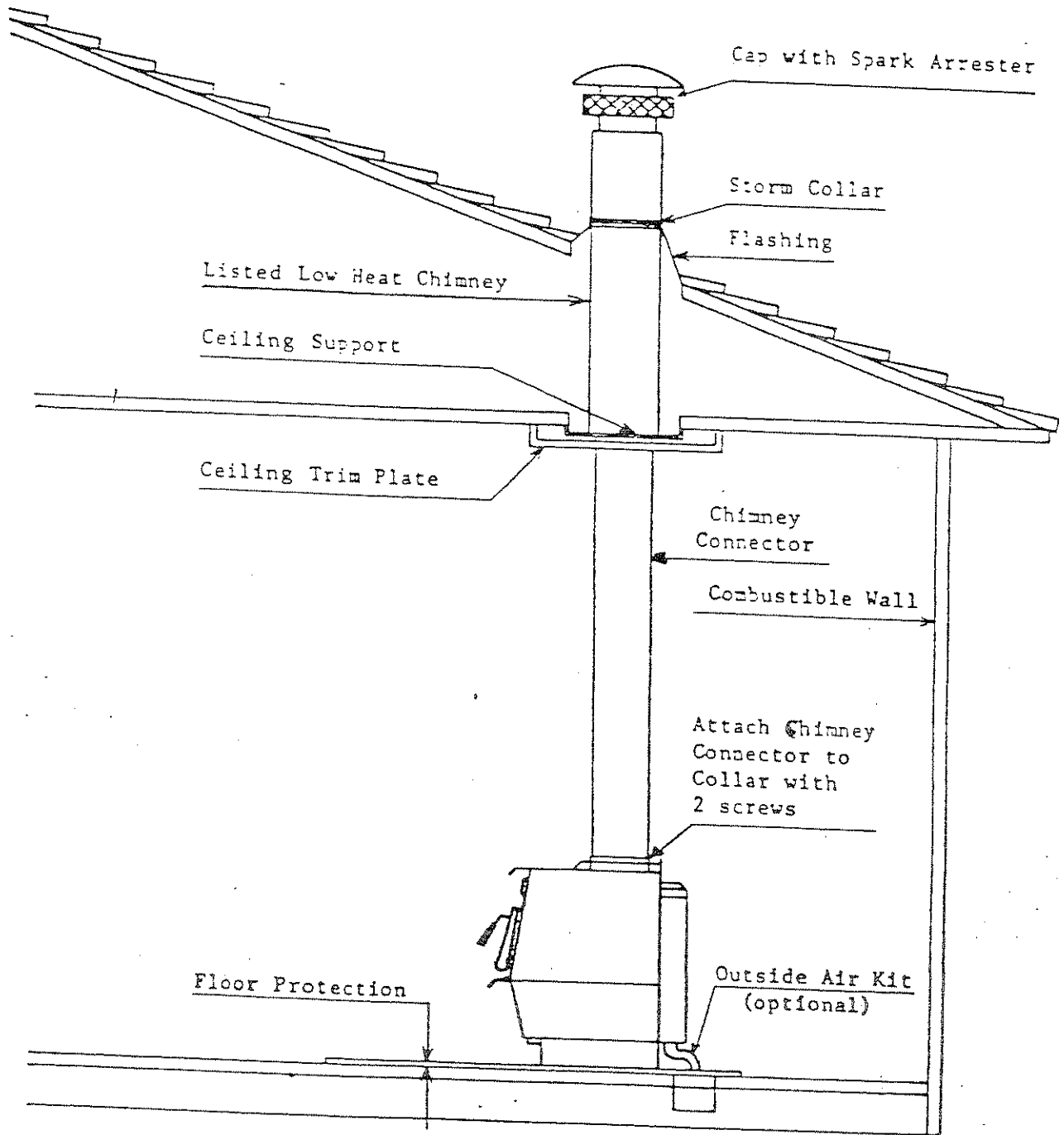

Figure 4: Residential Installation, with Prefabricated Chimney System.

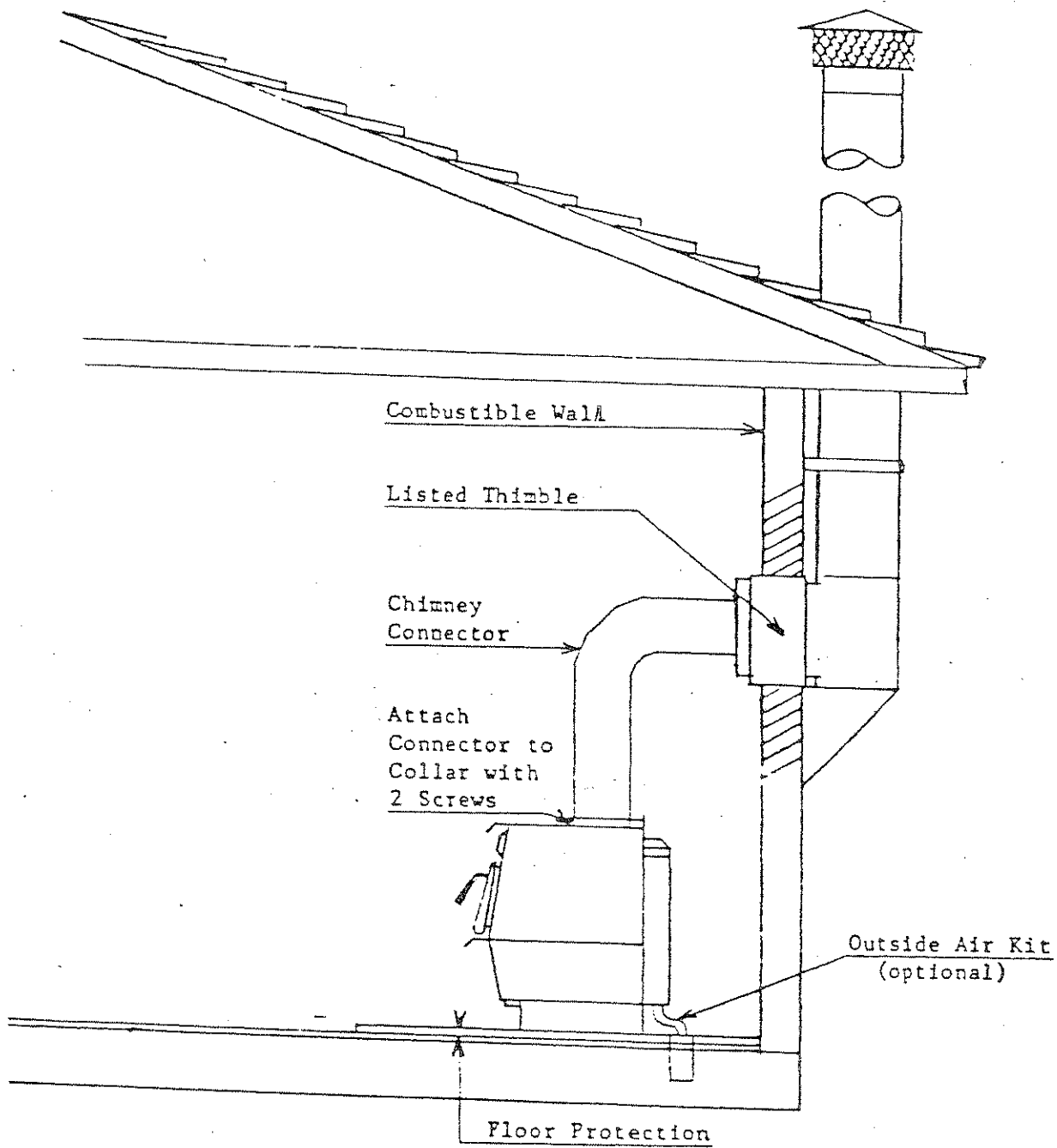

Figure 5: Residential Installation, with Prefabricated Chimney outside a combustable wall.

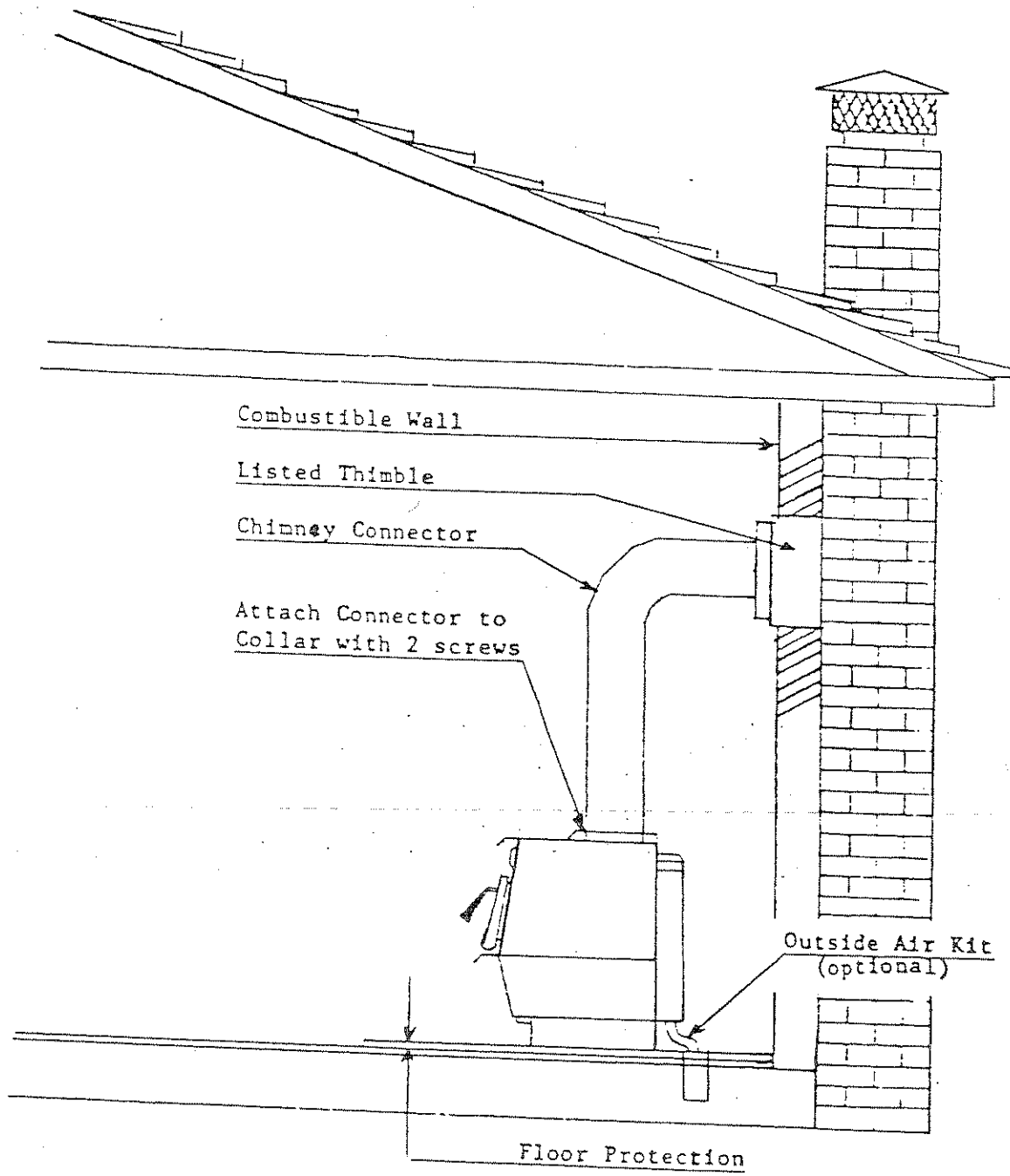

Figure 6: Residential Installation, using exterior masonry chimney.

OUTSIDE AIR SUPPLY

Residential Installations:
It is not mandatory that outside air for combustion be used. However, if local codes require it, an Outside Air Kit is available from your dealer.

Mobile Home Installations:
For proper installation, it is mandatory that outside air for combustion be used. The Outside Air Kit is included in the Mobile Home Kit.

Outside Air Supply, Figure 7.

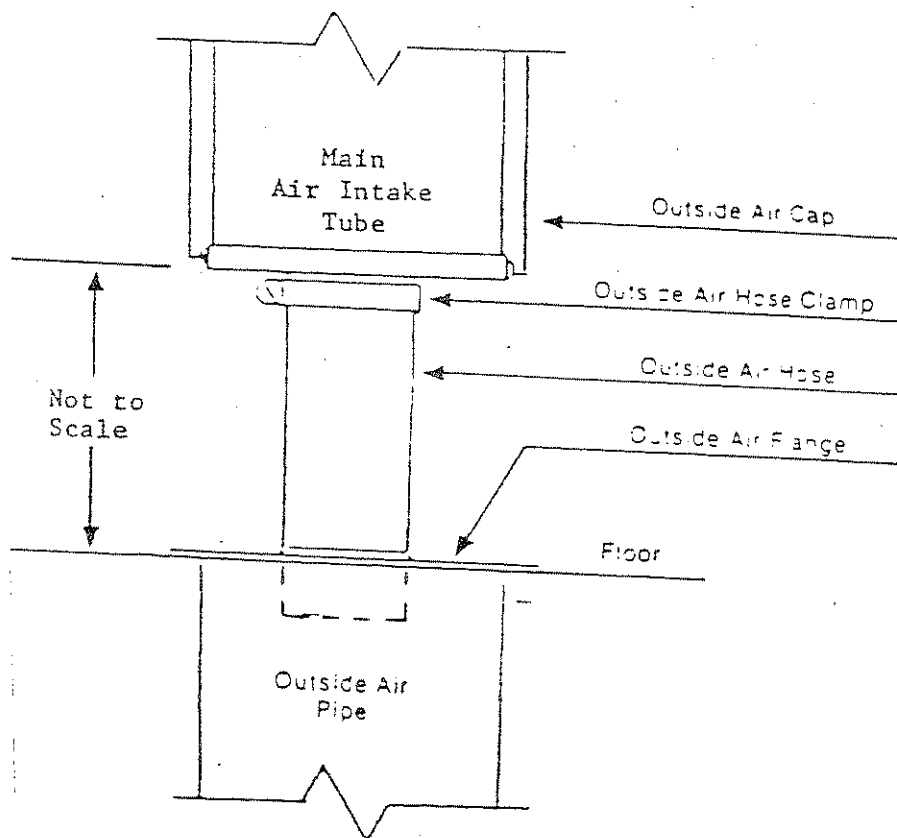

INSTALLING THE COMBUSTOR ASSEMBLY

See Figure 9 for proper parts nomenclature.

1. If the secondary air pipe is in place, remove the 1/4-20 x 2-1/2" bolt on the clamp, and remove the pipe which allows the flame shield to drop loose. Retain the pipe and flame shield. Open the By-Pass door.
2. Hold the combustor assembly upside down with the insulating gasket toward the stove top.
3. Carry the combustor assembly up through the By-Pass door and forward, then set it in the combustor seat on top of the dome with the insulating gasket down. You can gain additional support for the combustor assembly by reaching up through the flame shield opening with your other hand.
4. When the combustor assembly is in place, hold the flame shield in place while installing the secondary air pipe. Place the open end of the pipe in the hole on the stove back.
5. Push the flame shield and secondary air pipe up as tight as possible and tighten the 1/4-20 x 2-1/2" bolt.

REPLACING THE COMBUSTOR ASSEMBLY

The Blaze King Catalytic Thermometer on the top of the stove should read between 500 degrees and 1800 degrees F after the combustor has been in operation for several hours. (This does not mean the catalyst must reach 500 degrees F before it is operative. Some components of wood smoke will ignite at 150 degrees F.)

If the temperature does not exceed 1000 degrees F, even with a hot fire, over a 7-10 day period of regular use, contact your dealer. If the combustor must be replaced, follow this procedure:

1. The bolt holding the secondary air pipe in place will occasionally break while being removed. Before replacing the combustor have a 1/4-20 x 2-1/2" bolt and nut on hand.
2. Allow the fire to burn out and the stove to cool down.
3. Remove the secondary air pipe and flame shield. (See above).
4. Reach up through the By-Pass door opening and remove the combustor assembly.

The insulating material will have expanded (as compared to the new assembly) but it should come out without leaving any residue.

5. Inspect the combustor seat to determine if any residue is present. Wipe clean with a dry cloth. DO NOT USE DETERGENTS, STEEL OR METALLIC BRUSHES OR SOLVENTS.

6. Install the Combustor. Do not handle it any more than necessary for installation. The Combustor will have a stainless steel band holding an insulating material in place. This insulating material will expand when heated the first time to seal the Combustor to the Combustor seat, which is mounted on top of the Dome.

NOTE: Any time the combustor is removed, the insulating material forming the seal between the Combustor and the Combustor Seat MUST be replaced. Replacement combustors can be ordered from your dealer using the following part numbers (P/N):

King - P/N 4500

Princess - P/N 4400

7. Re-install the flame shield and the secondary air pipe.

CAUTION: The burning of metal foils, coal, plastic, garbage, sulphur, and diesel oil will make the catalyst in the combustor inactive.

CAUTION: The combustor is fragile, handle carefully. The performance of the catalytic device or its durability has not been evaluated as part of the certification.

OPTIMUM THERMOSTAT SETTING FOR CATALYTIC MODELS

(Refer to Fig. 8)

Any thermostat position between 1 and 3- $\frac{1}{2}$ will produce the desired clean burning characteristics. A thermostat setting of 3- $\frac{1}{2}$ will produce a maximum heat output of approximately 35,000 BTU/HR - a rating more than suitable for heating the average size home.

1. Cold start position - set the thermostat knob to 3- $\frac{1}{2}$. Leave it in this position until the larger pieces of wood have started to burn. By the time these larger pieces are burning, the combustor temperature will probably not exceed 100-150 degrees F. Close the loading door, the By-Pass Door will close automatically. The combustor temperature will begin to rise as the fire intensity builds up and moisture is driven from the wood.

Be patient. The combustor is effective between 500 and 1800 degrees F.. The air/fuel mixture and temperature must be stabilized before maximum combustion efficiency can be achieved.

2. As the combustor temperature passes the 500 degree point, further adjustment to achieve the desired room temperature should be made in small increments (for instances; from position # 3 to position # 2) for the most effective cleaner burning operation. Even this small change may reduce the clean burn slightly for 10 - 15 minutes. Changes, generally speaking, should be made as few times each day as possible.

When the thermostat knob is abruptly moved from high to low, more smoke is produced, so the catalyst has more fuel; consequently the catalyst thermometer may register a higher heat for several hours after the thermostat is turned down.

3. Reload position - when you reload the stove you will reduce the clean burning characteristics for several minutes until the new wood gets a good start.

4. The thermostat is adjusted at the factory and should not be tampered with. If the thermostat breaks, the damper will close automatically.

Figure 8: Thermostat Decal

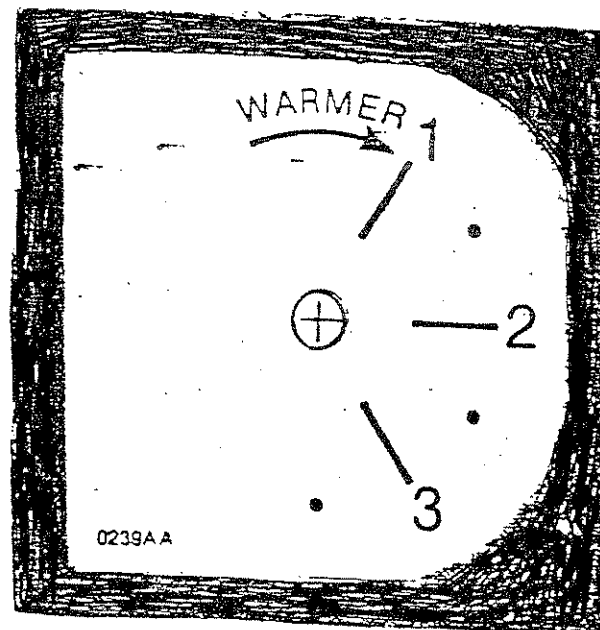

CREOSOTE - FORMATION AND NEED FOR REMOVAL

When wood is burned slowly, it produces tar and other organic vapors which combine with expelled moisture to form creosote. The creosote vapors condense in the relatively cool chimney flue of a slow-burning fire. As a result, creosote residue accumulates on the flue lining. When ignited, this creosote makes an extremely hot fire.

PREVENT CREOSOTE FIRES: Inspect Chimney and Chimney Connector TWICE monthly during the heating season to determine if a creosote build-up has occurred. If creosote has accumulated, it should be removed to reduce the risk of a chimney fire.

The basic design of this catalyst equipped stove will reduce creosote accumulation to a very low level. However, the frequency of start-up operations and the temperature at which the stove is operated on a regular basis can affect that accumulation. The inspection frequency noted above is still a vital step in the safe operation of any woodburning system.

ICE - FORMATION AND PREVENTION

Most of what you see coming from the chimney of a properly operating catalytic stove is water vapor. In extremely cold weather - and with some exterior chimneys - this vapor may freeze in the chimney, to the point of actually blocking the chimney and extinguishing the fire. In such weather, occasionally burn the stove with the bypass open (and the loading door open) to melt any possible ice buildup.

FUEL

THIS STOVE IS FOR USE WITH SOLID WOOD FUEL ONLY.

Do not burn trash, paper, pine branches or artificial fire logs. Such abuse may void the warranty.

When selecting wood for a catalytic stove, do not use extremely dry wood or small pieces. Dry or small pieces of fuel will release too many volatiles early in the burn and flood the catalyst, keeping it from reaching the clean burn stage. In extreme cases, the catalyst may not reach clean burn for up to three hours.

CAUTION: Do not store fuel within the space heater installation clearances or within the space required for charging and ash removal.

FLAMMABLE LIQUIDS

NEVER use gasoline, gasoline-type lantern fuel, kerosene, charcoal lighter fluid or similar liquids to start or "freshen up" a fire in this stove. Keep all such liquids well away from the stove while it is in use.

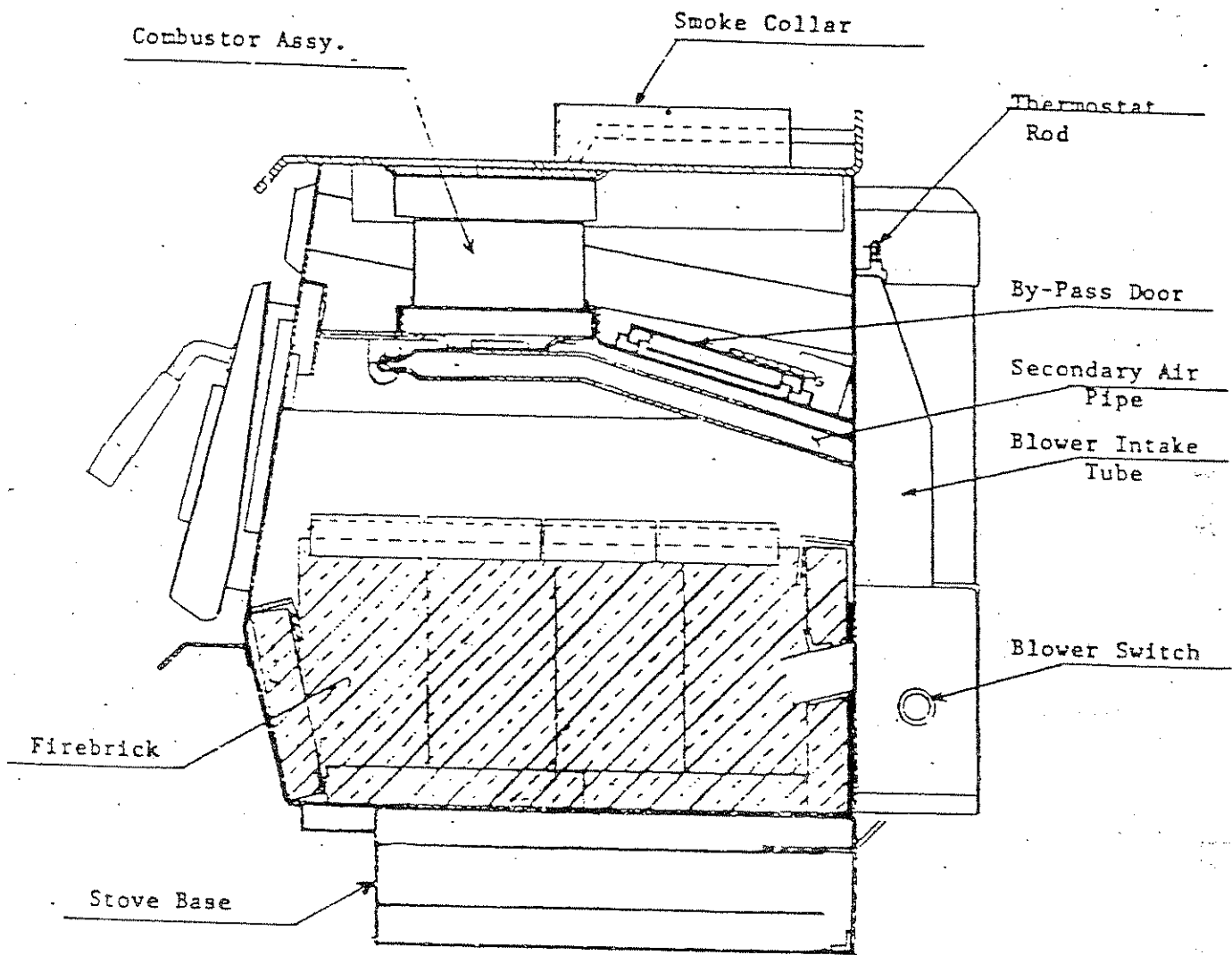

Figure 9: Cutaway of Blaze King Catalytic, freestanding stove.

0341B

INITIAL START-UP SEQUENCE

NOTE: As you heat up the stove for the first time, the paint will go through a curing process and will give off an odor. To minimize this inconvenience, burn the stove at a low temperature setting for several hours. If the odor gets too unpleasant, you may have to open a door or window slightly until the odor dissipates. It might even be a good idea to burn the first fire with the stove outside.

1. DO NOT USE GRATE. BUILD FIRE DIRECTLY ON THE HEARTH.
2. Set the thermostat to position #1.
3. Open the loading door and open the By-Pass door.
4. Place several balls of paper toward the back of the firebox and place a fairly large quantity of kindling on top of the paper.
5. Lay two or three medium size (approx. 3") pieces of wood on top of the kindling. Light the fire and allow it to get a good start - Keep the door open but DO NOT LEAVE THE STOVE UNATTENDED.
6. When the fire has the larger pieces of wood burning, close the loading door. The By-Pass door will close automatically.

CAUTION: Closing the loading door too soon may cause a new fire to go out. Allow the kindling and most of the larger logs to get started before closing the loading door. DO NOT leave your BLAZE KING unattended when the doors are not tightly closed.

NOTE: Leaving the loading door open after the fire is well started may cause premature failure of the catalytic combustor.

7. Turn on the fan as desired.
8. When nearly all the wood in the firebox is burning, finish loading the stove. Proceed to "reload sequence".

NOTE: Probably the least understood requirements in maintaining a good fire is that of establishing a good base of coals. Many new stove users hesitate to load enough wood to sustain a fire. A good bed of hot coals will maintain a more even temperature as well as getting the new load of wood started easily.

Mobile Home models draw combustion air into the stove through the Outside Air Kit. Residential models usually obtain air from the room. WARNING: It is essential that a source of fresh air into the room be provided at all times.

Review the position(s) of smoke detectors if you have them installed. If they are too close to the stove area they may be set off by wisps of smoke during loading, or heat rising from normal operating temperature, etc..

RELOADING

CAUTION: This stove is not designed to be operated with the door open.
OPERATE WITH DOORS CLOSED ONLY.

At each reloading, load the stove fully. It is not necessary to open the door often. Every time the door is opened, more creosote is deposited in the chimney.

Let each load burn down to a small coal bed. Frequent reloading will cause major fluctuations in temperature and wood/air mix, thereby reducing efficiency.

Four or five 5" or 6" diameter logs may burn for up to 24 hours. This will vary considerably with the variables of stove model, type of wood, whether the wood is "seasoned", the thermostat setting, the position of the stove in the house, and how well the house is insulated. The stove can be fully loaded without increasing the heat output. The stove will simply burn longer.

RELOADING SEQUENCE

1. To add fuel to the stove, rotate the loading door handles outward but do not open the loading door. This short release area will allow the automatic By-Pass door closing mechanism to release.
2. Open the By-Pass door, then open the loading door and load the firebox.
3. Close the loading door. The By-Pass door will close automatically.

CAUTION: After the fire has been allowed to liven up and the door closed, DO NOT open the door for at least 4-5 minutes. Hot gasses build up right after the door is closed and the addition of oxygen when the door opens will cause a rapid combustion, sending smoke into the room.

CAUTION: Always open the By-Pass door BEFORE opening the loading door completely to feed the fire. Keep the By-Pass door closed at all other times.

DOOR GASKETS

Check the loading door gasket for deterioration at least twice each heating season. The By-Pass door gasket should be checked for deterioration before the start of each heating season.

ASH REMOVAL

Ashes should be removed any time they start to cover the draft inlet into the firebox. The frequency with which you need to empty the ashes depends on the type of fuel being used. Remove ashes only when they are cold so the hot coals are not dumped where they may start a fire.

DISPOSAL OF ASHES

Ashes should be placed in a metal container with a tight fitting lid. The closed container of ashes should be placed on a non-combustible floor or on the ground, well away from all combustible materials, pending final disposal. If the ashes are disposed of by burial in soil or otherwise locally dispersed, they should be retained in the closed container until all cinders have thoroughly cooled.

PAINT

If the finish on the stove ever becomes blemished, you can repaint with high temperature paint available from your dealer. DO NOT paint the stove while it is HOT.

AUTHORIZED SERVICE REPRESENTATIVE

Your local Blaze King dealer is your authorized service representative. Should you have any problems with operations or maintenance of your Blaze King stove, contact him as soon as possible. He will assist you in resolving any operation problems, provide replacement parts and/or arrange warranty repairs as required. He will need information such as model, serial number, date of purchase, and a summary of the problem. A list of some of the more common replacement parts is given below.

Table 3.

REPLACEMENT PARTS

ITEM	PART #	DESCRIPTION
Ceramics		
Blaze King	0114	Orange, Brown, Blue, Green, Black
Blaze Princess	0116	Orange, Brown, Blue, Green, Black
Door Handles	0118	
Motors	0175AA	
Spray Paint	0128	
Thermostat Knob	0102	Aerosol Can
Outside Air Kit	0150	
Door Gasket	0180	
By-Pass Door Gasket	0182	
Combustor Assembly (King)	4500	
Combustor Assembly (Princess)	4400	
Combustor Seat Gasket	0341	
Blaze King Catalytic Thermometer	0342	Replacement Gasket

BLAZE KING - ADDENDUM 1
Model KEJ-1101
RESIDENTIAL INSTALLATION, USING PREFABRICATED CHIMNEY

Refer to Figure 10.

INSTALLATION

1. Set hearth and stove in location for marking holes in accordance with the dimensions listed on the label and figures of these instructions.
2. Mark the position for the hole in the ceiling and roof by using a string and plumb-bob.
3. Check that the intended location will not interfere with floor joists, ceiling joists, or rafters before proceeding further.
4. If required, mark the position of the hole for the outside air pipe.
5. If required, move the stove and, using a saber saw with a suitable blade, cut a 6" hole for the outside air pipe.
6. Cut a pilot hole in the ceiling.
7. Cut a 16-1/2" square hole and frame in both sides of this hole in both ceiling and roof. Refer to the pipe manufacturer's installation instructions. (FOR SAFE INSTALLATION HOLE MUST NOT BE SMALLER THAN 16-1/2".)
8. Measure the distance from the ceiling to the top of any combustible material. If required, trim the top of the joist shield so that it will clear any combustible material when installed in step 11. Note that the joist shield may extend completely through the roof on some installations and may require trimming only to allow the proper positioning and attachment of the roof flashing and storm collar.
9. Slide the stove back into position.
10. To start installing pipe, turn the first section of pipe upside down and slip the crimped edge of the pipe inside the smoke collar.
11. Install the remaining lengths of pipe one on top of the other to the finished height of the chimney connector, and secure to each other. When approaching the ceiling, slip the ceiling support and joist shield over the chimney so that after the chimney is extended through the ceiling, the ceiling support can be secured to the ceiling. The joist shield rests on the ceiling support but is not secured to it. The Joist Shield and Ceiling Support are packaged together. Refer to pipe manufacturer's Installation Instructions.
12. Slip the roof flashing down over the chimney and nail to the roof, being careful to keep the pipe centered in the opening. NOTE: To meet the code, the chimney must extend above the roof at least three feet and two feet above any area of the roof within ten feet of the chimney.
13. If required, install the Outside Air Pipe and secure to the floor. Attach the Outside Air Cap to the bottom of the main Air Intake Tube. Push a few inches of Outside Air Hose down through the hole in the Outside Air Flange. Place the Outside Air Hose Clamp over the top end of the Outside Air Hose and install the Outside Air Hose to the Outside Air Cap. Tighten the Outside Air Hose Clamp to hold the Outside Air Hose in place. Adjust the length of the Outside Air Hose by moving it in or out of the Outside Air Flange. When the desired position have been obtained, secure the Outside Air Hose to the Outside Air Flange with a small bead of high temperature silicone sealer.
14. Install the Top Rails. Insert the long end through the hole in the back of the stove top, and rotate the rail until it drops through the hole in the stove top. Attach with the 7/16" nut provided. If push-nuts and bowed washers are used: After the rail is in place, hold it down from above, put the bowed washer on from below, place the push-nut in the open end of a 1/2" socket and push or tap it in place.

15. Install the ceramic in the ceramic ring. Mount the assembly to the stove with the 6-32 x 1/4" screws provided. REMEMBER: These ceramics are a fragile clay product and must be handled carefully.

16. The Blaze King stove motors are equipped with a three-prong (grounded) plug to prevent shock hazard. THIS PLUG SHOULD BE INSERTED DIRECTLY INTO A PROPERLY GROUNDED, THREE-PRONGED RECEPTACLE. DO NOT CUT OR REMOVE THE GROUNDING PRONG FROM THIS PLUG. Do not route the power cord in front of this heater.

FLOOR PROTECTION

The floor under the stove must be protected with a noncombustible material.

The floor protector must extend beyond the stove: 6" from each side; 18" from the front; 6" from the back. An area 42" x 52" must be protected. These dimensions provide the required floor protection clearances.

The floor protector must extend to the wall under a wall exit installation and must extend 2" beyond each side of the chimney connector.

OUTSIDE AIR SUPPLY

For proper installation, it is not mandatory that outside air for combustion be used. However, if local codes require it, an OUTSIDE AIR KIT is available from the dealer who sold you the stove.

The outside air inlet hose is a flexible tube which can be bent to take outside air in through the wall or up through the floor. The flexible tube will allow some adjustment over or around floor joists or plumbing. DO NOT CHANGE THE STRUCTURAL INTEGRITY OF THE FLOOR. This air hose must be kept open at all times to provide outside air for combustion. See Figure 7.

Figure 10. KEJ-1101 RESIDENTIAL INSTALLATIONS
 MINIMUM CLEARANCES TO COMBUSTIBLE SURFACES

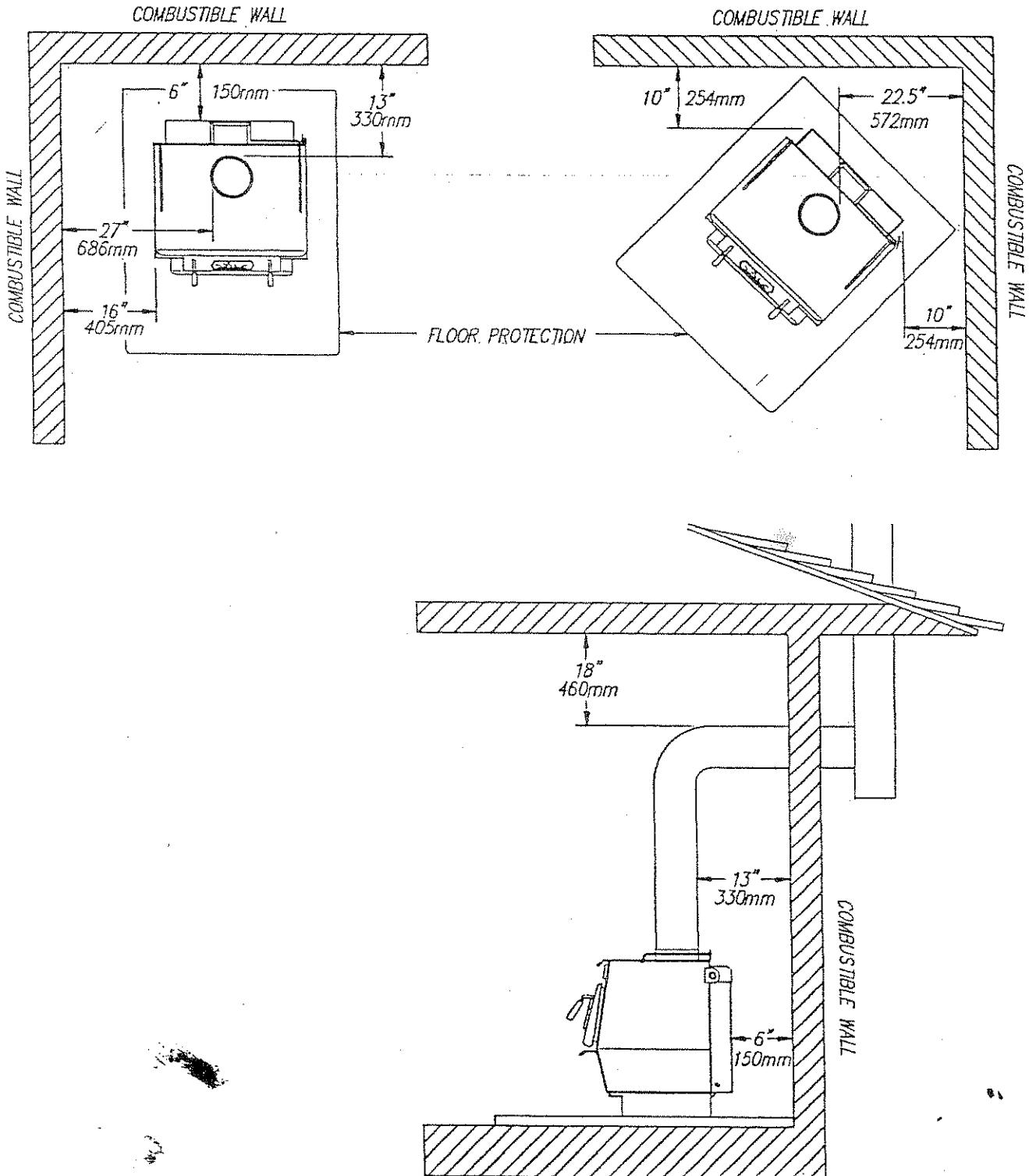

BLAZE KING - ADDENDUM 2

Model KEJS-1101

RESIDENTIAL INSTALLATIONS USING PREFABRICATED CHIMNEY
ADDITIONAL REDUCED CLEARANCES WITH EXTERNAL SIDE SHIELDS INSTALLED

Refer to Figure 11.

With the addition of external side shields (P/N 3324/3325), this model can be installed with the minimum clearances shown below. Side shields must be welded on AND the stove MUST also have a Rear Heat Shield (P/N 3342).

FOR INSTALLATION, FLOOR PROTECTION, AND OUTSIDE AIR SUPPLY Refer to Addendum 1.

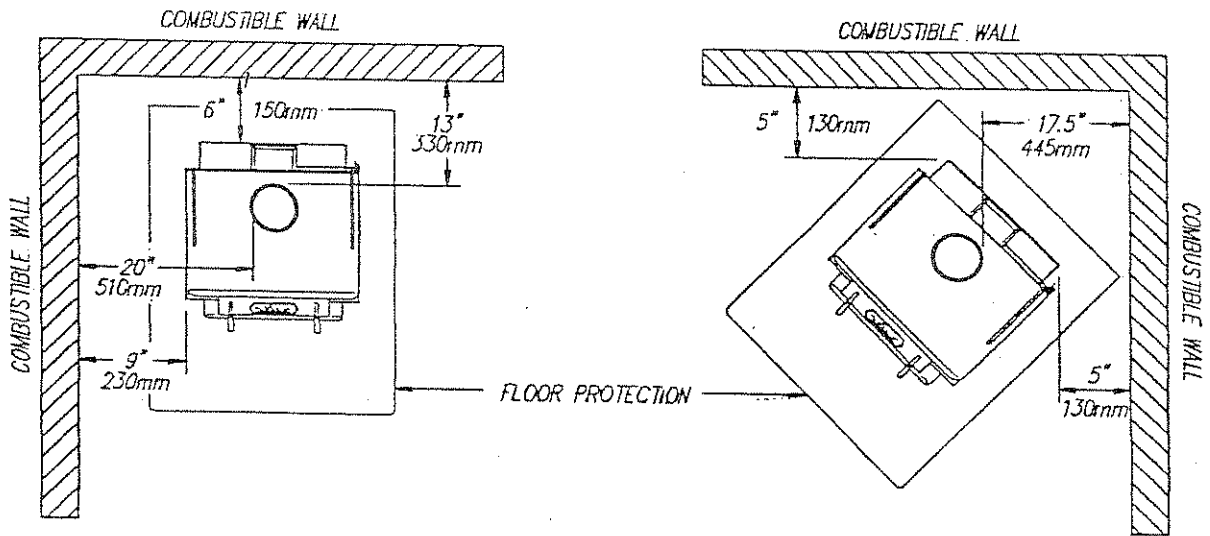

Figure 11.
KEJS-1101
Residential Installations

ADDITIONAL REDUCED CLEARANCES
with EXTERNAL SIDE SHIELDS

MINIMUM CLEARANCES TO
COMBUSTIBLE SURFACES

