

OM18B
ED-12/89

OWNER'S
INSTALLATION AND OPERATION INSTRUCTIONS

BLAZE KING
WOODSTOVES

Auto Light Pellet Stoves
Models PAL-4001 and PAL-4200

BLAZE KING
3301 EAST ISAACS
WALLA WALLA, WA 99362
509/529-9820

SAVE THESE
INSTRUCTIONS

Copyright © 1989 Western Fab & Finish, Inc.

BLAZE KING
PELLET AUTO LIGHT,
MODELS PAL-4001 & PAL-4200
OWNER'S INSTALLATION AND OPERATIONS MANUAL

SAFETY NOTICE

IF THE BLAZE KING PELLET STOVE IS NOT PROPERLY INSTALLED, A HOUSE FIRE MAY RESULT. FOR YOUR SAFETY, FOLLOW THE INSTALLATION DIRECTIONS. CONTACT LOCAL BUILDING OR FIRE OFFICIALS ABOUT RESTRICTIONS AND INSTALLATION INSPECTION REQUIREMENTS IN YOUR AREA.

THIS STOVE MUST BE CONNECTED TO A LISTED PELLET VENTING SYSTEM. EXISTING MASONRY OR MANUFACTURED CHIMNEY MUST NOT BE USED.

WARNING

IMPROPER ASSEMBLY, INSTALLATION, MAINTENANCE OR OPERATION OF THIS APPLIANCE CAN CAUSE DAMAGE TO PROPERTY, SERIOUS INJURY OR DEATH.

READ THESE INSTRUCTIONS.

SAVE THESE INSTRUCTIONS

BLAZE KING
3301 E. Isaacs
Walla Walla, WA 99362
509/529-9820

Wharlock Hershey Listed Room Heaters, Pelletized Fuel Type
 Also suitable for Mobile Home Installation



Model: PAL 4001 □ PAL 4200
 TL-116
 NER-OA 219
 Tested to: UL 1482/9/80/JAPP,
 UL 331/7/81), ULC S627/CSA E366.2
 This pellet burning appliance has been tested and listed for use in
 manufactured homes in accordance with Oregon administrative rules
 814-23-900 through 814-23-909.

"PREVENT HOUSE FIRES"

Install and use only in accordance with manufacturer's installation
 and operation instructions. Contact local building or fire officials
 about restrictions and installation inspection in your area.

**DO NOT CONNECT THIS UNIT TO A CHIMNEY
 FLUE SERVING ANOTHER APPLIANCE.**

Refer to local building code and manufacturer's instructions for
 precautions required for passing a pellet vent through a combustible
 wall, floor or ceiling.

WARNING: Do not install appliance in a sleeping room.

Input Rating: 47,000 Btu/hour

Electrical Rating: 120 volts, 60 Hz, single phase, 7.5 amps.

DANGER: Risk of electrical shock. Disconnect power before servicing
 unit. Do not route power cord beneath heater.

Fuel: For use with 3/8" (6 mm) and/or 5/16" (8 mm) wood pellet fuel.

MINIMUM CLEARANCES TO COMBUSTIBLE MATERIALS (IN/MM)
 All clearances measured from base of stove

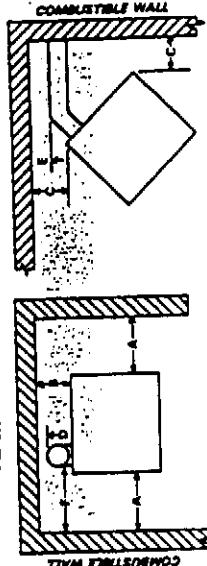

Floor protector must be noncombustible material, extending beneath heater
 and 12" (305 mm) to the front and 2" (50 mm) to the sides/rear of the base
 as indicated.

	HORIZONTAL WALL, VENT EXIT	VERTICAL OR DIAGONAL WALL, VENT EXIT
Model 4001	12" (305 mm)	12" (305 mm)
Model 4200	13" (330 mm)	13" (330 mm)
Backwall to unit	6" (150 mm)	3.5" (90 mm)
Adjacent wall to unit	3.5" (90 mm)	3.5" (90 mm)
Backwall to vent	N/A	3" (75 mm)
Adjacent wall to vent	3" (75 mm)	3" (75 mm)
Sidewall to vent	12" (305 mm)	12" (305 mm)
	13" (330 mm)	13" (330 mm)

ALCOVE DIMENSIONS: 64" (1626 mm) min. height x 38" (965 mm)
 min. width x 45" (1130 mm) max. depth. Maintain clearance to side
 wall from stove top of 20" (510 mm) for 4001 and 18.5" (468 mm)
 for 4200. In alcove, vent pipe exit permitted horizontally through rear
 wall or through floor only.

VENTING SYSTEM: 4" (100 mm) diameter, L-Vent pellet pipe and
 2.25" (58 mm) auto exhaust and/or bendable stainless pipe from
 stove to exhaust fan. 4" (100 mm) diameter, L-Vent pellet vent pipe
 from exhaust fan to rain cap.

TO START STOVE: Turn wall thermostat to "ON".
TO STOP STOVE: Turn wall thermostat to "OFF".

Inspect and clean pellet vent frequently. Under certain conditions of
 use, creosote buildup may occur rapidly.

DANGER: "RISK OF FIRE OR EXPLOSION" - Do not burn gar-
 bage, gasoline, drain oil and other flammable liquids.

WARNING: Do not operate with fuel loading, ash removal, or
 viewing doors open. Remove ashes only when unit is
 cool. Do not store fuel or other combustible material
 within marked installation clearances.

CAUTION: Keep children away. Do not touch door, door glass or
 front of stove during operation.

BLAZING!

3301 E. Issac
 Walla Walla, WA 99362
 (509) 529-9820

This model is exempt from E.P.A. Certification under 40 CFR 60.531
 By definition ("WOOD HEATER (a) AIR-TO-FUEL RATIO")

DO NOT REMOVE OR COVER THIS LABEL.

Made in U.S.A.

Manufacturer Date:

- 1989 1990 1991 1992 1993 1994
- JAN FEB MARCH APRIL MAY JUNE
- JULY AUG SEPT OCT NOV DEC

Dear Customer:

Thank you for purchasing a BLAZE KING Auto Light Pellet Stove. In addition to being some of the most attractive and reliable units on the market, these Auto Light stoves also offer the most carefree operation.

Unlike most conventional stoves, the Auto Light can actually turn itself off when not needed, then automatically rekindle the fire when the thermostat calls for heat. You never have to strike a match — just set the thermostat and the Auto Light provides heat when you need it. And because it turns itself off when not needed, it never wastes fuel.

This owner's manual explains the steps required to safely install, operate and maintain your new BLAZE KING Auto Light Pellet Stove (hereafter referred to as the "stove"). Be a responsible stove owner: Carefully read these requirements for safe installation and proper operation BEFORE installing and using your stove. Once it's installed, remember that it requires periodic maintenance to continue to operate safely and efficiently, as does any heating system.

Obtain permits from the building inspector or fire department, if local laws require. Check local building and fire codes before installing your stove. When you have completed the installation, have it checked by your local inspector. Disregarding inspection and code requirements may jeopardize your homeowner's insurance. Since some insurance carriers require notification of a stove installation, contact your insurance agent. We want your Auto Light Pellet Stove to give you a lifetime of trouble-free operation.

While we have made every effort to make these instructions as complete as possible, some installation or operating conditions may not be covered. If you have any questions that are not answered here, contact your BLAZE KING dealer, local building inspector, fire department or our customer service department at BLAZE KING, Walla Walla, WA (509/529-9820).

The Management and Employees of
BLAZE KING

KEEP THIS MANUAL FOR FUTURE REFERENCE

***** SECTION 1 - TABLE OF CONTENTS *****

SECTION 2 - WARRANTY 5
 Disclaimer of Warranties & Limitation of Liability. 5
 Other Legal Rights of the Purchaser 5
 SECTION 3 - DEFINITIONS. 6
 SECTION 4 - SAFETY 9
 Venting System Fire 9
 Smoke Detectors 9
 Fire Extinguishers. 9
 Building & Fire Codes 9
 Children. 10
 Clearances to Combustible Materials 10
 Fuel. 10
 Electrical Power 10
 Disposal of Ashes 10
 Chimneys. 11
 Creosote & Fly Ash. 11
 Viewing Door. 11
 Ash Drawer. 12
 Pellet Hopper Lid 12
 SECTION 5 - SPECIFICATIONS 13
 SECTION 6 - INSTALLATION PREPARATION 14
 Listing 14
 Warranty Card 14
 Product Inspection. 14
 Tools Needed for Installation 15
 Additional Supplies Needed. 15
 Planning For Your Stove Placement 16
 Floor Protection. 16
 Clearances to Combustibles. 16
 General Installation Notes. 20
 Mobile Home Installation Notes. 21
 SECTION 7 - ASSEMBLY & INSTALLATION. 22
 Stove Assembly. 22
 Vent and Exhaust Pipe Assembly Information. 22
 Installation Instructions 24
 SECTION 8 - OPERATION. 33
 Controlling the Stove 33
 The First Fire. 33
 Reloading 34
 Self-Cleaning 34
 SECTION 9 - MAINTENANCE. 35
 Authorized Service Representative 35
 Venting System Fire 35
 Creosote. 35
 Fly Ash 35
 Emptying Ash Drawer 36
 Inspecting and Cleaning Exhaust Fan 36
 Maintaining Gaskets 37
 Cleaning Viewing Door Glass 37
 Viewing Door Glass Replacement. 37
 Maintenance Schedule. 38

***** Section 2 - WARRANTY *****

BLAZE KING offers a five-year limited stove warranty. A copy of this warranty is packaged with the stove.

To register your warranty, fill out and return the warranty registration card included with this stove. You will find the model number and serial number on the tag on the stove's pellet hopper lid. If the warranty card is missing, you can obtain one from your local dealer.

DISCLAIMER OF WARRANTIES AND LIMITATION OF LIABILITY

THERE ARE NO UNDERSTANDINGS, AGREEMENTS, REPRESENTATIONS OR WARRANTIES, EXPRESSED OR IMPLIED, INCLUDING WARRANTIES OF MERCHANTABILITY OR FITNESS FOR A PARTICULAR PURPOSE, OTHER THAN THOSE SPECIFICALLY SET OUT BY THE "BLAZE KING LIMITED WARRANTY." THIS WARRANTY STATES THE ENTIRE OBLIGATION OF THE MANUFACTURER AND SELLER. THE CONTENTS OF THIS DOCUMENT SHALL NOT BECOME PART OF, OR MODIFY, THIS WARRANTY.

The information, recommendations, descriptions and safety notations in this document are based on BLAZE KING'S judgement and experience regarding pellet stoves. THIS INFORMATION SHOULD NOT BE CONSIDERED TO BE ALL-INCLUSIVE OR COVERING ALL CONTINGENCIES. In no event will BLAZE KING be responsible to the user in contract, in tort (including negligence), strict liability or otherwise for any special, indirect, incidental or consequential damage or loss whatsoever resulting from the use of the information, recommendations, descriptions and safety notations contained herein. If further information is required, consult your local building or fire officials, your BLAZE KING dealer or BLAZE KING.

OTHER LEGAL RIGHTS OF THE PURCHASER

This warranty gives you specific legal rights, and you may also have other rights which may vary from state to state. If you do not agree to the purchase of the pellet stove on the terms and conditions set out in this warranty, then you must return the pellet stove to the dealer prior to use or installation, and the purchase price will be refunded.

***** SECTION 3 - DEFINITIONS *****

ALCOVE

For the purposes of this manual, an alcove is defined as a recess or partly enclosed extension connected to, or forming part of, a room. It may be on either an interior or exterior wall. The minimum dimensions for an alcove in which this stove may be installed are 38 inches (96.52 cm) wide, 54 inches (137.16 cm) from the top of the floor protector to the ceiling and 48 inches (121.92 cm) deep.

AUGER

The auger, which turns at a constant speed, delivers a metered amount of pellet fuel to the firepot. The auger does not turn at all times -- its periodic operation is controlled by the fuel feed selector knob on the side of the stove.

BENDABLE, STAINLESS-STEEL TUBING

Stainless-steel tubing designed to be used as pellet stove exhaust vent pipe. This tubing is bendable so that it can be used to make elbows. Use only Z-Flex Model SF 2-inch liner, listed by Warnock Hersey to ICBO TL116.

CHIMNEY

One or more passageways, vertical or nearly so, for sending flue gases (smoke) to the outside atmosphere. There are two common types of chimneys:

1. Listed Residential Type and Building Heating Appliance Type Chimney: A chimney composed of listed factory-built components assembled in accordance with the terms of listing to form the completed chimney.
2. Masonry Chimney: A field-constructed chimney of solid masonry units, bricks, stones, listed masonry chimney units or reinforced concrete, lined with suitable flue liners built in accordance with applicable building code requirements.

Never vent your pellet stove into a "Class B" gas vent chimney. Use only listed "L" vent pellet pipe.

The use of chimneys, as defined here, is not allowed for venting a BLAZE KING Model PAL-4001 or Model 4200 pellet stove. (The above definitions are for information only.)

CHIMNEY CONNECTOR

Also known as stove pipe. The use of chimney connector is not allowed in BLAZE KING pellet stove installations.

COMBUSTIBLE MATERIAL

Material made of or surfaced with wood, compressed paper, plant fibers, plastics or other materials that will ignite and burn, whether flameproofed or not, or whether plastered or unplastered.

COMBUSTION AIR INLET

In tight contemporary homes, using outside combustion air is generally desirable. BLAZE KING Auto Light pellet stoves are designed to use outside air. The combustion air inlet is located on the back of the stove, around the exhaust outlet. Combustion air is drawn from outside the house, through the venting system into this opening, then through the control box and into the firebox.

DOOR, VIEWING

The door on the front of the stove, with viewing glass installed. This door must be closed and latched tightly whenever the fire is burning. When cleaning the stove, wait 1/2 hour after the fire is out or until the stove is sufficiently cooled before opening the viewing door.

DRAWER, ASH

The drawer on the bottom front of the stove which receives ashes from the combustion chamber. This drawer must be closed and locked tightly whenever the fire is burning. When cleaning the stove, wait 1/2 hour after the fire is out or until the stove has sufficiently cooled before opening this drawer.

EXHAUST PIPE

Z-Flex Model SF 2-inch bendable, stainless-steel liner or 2 1/4 inch automotive exhaust pipe, mounted inside the listed pellet vent to route exhaust gases outside the home.

FAN, COMBUSTION-EXHAUST

Located outside the home, near the end of the venting system.

FANS, CIRCULATING

Two axial fans circulate room air around the firebox and back into the room.

FIREPOT

The firepot sits near the bottom center of the firebox. It is constructed of cast iron and stainless steel.

FLOOR PROTECTOR

Noncombustible material set on the floor area underneath the stove and extending in front, to the sides and to the rear of the stove. For the BLAZE KING pellet stoves, use any non-combustible material or a Listed Floor Protector. Floor protector must extend 2 inches (5 cm) on each side of stove base, 12 inches (30.5 cm) in front of stove base, and to the wall behind stove. When the listed pellet vent does not extend back through the rear wall behind the stove, but goes another direction (up, down or sideways) the floor protector must extend to the wall under the venting system and must extend 2 inches (5.08 cm) beyond each side of the venting system. Read the installation instructions. See page 16 for required dimensions of floor protector.

FUEL

Pellet fuel for your BLAZE KING Auto Light stove should meet or exceed APFI standard APFI-PF 1-88. In addition, the pellets should be no larger than 5/16 inch (0.8 cm) in diameter and 1 inch (2.54 cm) long. Larger pellets will not feed properly and may jam the auger.

The pellet fuel should contain at least 97% wood or bark, and not more than 1% noncombustible ash content. Use of pellets with a higher ash content will require more frequent cleaning of the combustion chamber, ash drawer, and venting system; and may void the stove's warranty.

Pellets containing more additives will produce more heat (Btu/hour). Some pellet manufacturers add binders which increase the pellets' hardness and ease the manufacturing process.

Pellet fuel which includes fine, loose material will not burn as cleanly. If you use such fuel, you may need to clean the combustion chamber, ash drawer and venting system more frequently. Consider screening the pellet fuel to eliminate most of the loose material.

Pellet fuel used in this stove MUST BE DRY. Damp or wet pellets will break, compact, burn poorly or not at all, and may jam the auger.

Contact your dealer for recommended pellet fuel brands.

CAUTION

THIS PELLET STOVE IS FOR USE WITH SOLID WOOD PELLET FUEL ONLY. DO NOT USE PELLETS THAT HAVE BEEN EXPOSED TO MOISTURE. DO NOT USE GASOLINE, GASOLINE-TYPE LANTERN FUEL, KEROSENE, CHARCOAL LIGHTER FLUID OR SIMILAR LIQUIDS TO START OR "FRESHEN UP" A FIRE IN THIS APPLIANCE. KEEP THESE FLAMMABLE LIQUIDS WELL AWAY FROM THIS APPLIANCE WHILE IT IS IN USE.

IGNITER

The patented igniter ring, located in the firepot.

LID, PELLET HOPPER

The lid on the top back of the stove through which pellet fuel is poured into the hopper. The area on top of the hopper MUST BE CLEAN before the hopper lid is closed.

LISTED

Meeting Underwriters Laboratories Inc. specifications when installed properly.

MOBILE HOME

A residence mounted on wheels, or capable of having wheels installed, for the purpose of moving it to another location. Typically, a residence with a steel frame supporting the structure and providing an axle(s) for the installation of wheels to move it into the location and out again. Frequently referred to as a "manufactured home" to differentiate between travel trailers and more permanent residences. For use in mobile homes, this appliance is listed to be connected to any listed, 4-inch "L" pellet vent. Use of any other venting system or components in mobile homes voids the stove listing and the warranty.

(Some state or local jurisdictions may not allow the installation of pellet stoves in mobile homes. Contact local building or fire officials for information regarding local codes.)

THIMBLE

A listed, manufactured product installed in combustible walls and floors through which the pellet vent passes to the outside. It is intended to prevent the walls from igniting.

VENT

A listed Residential Type and Building Heating Appliance Type pellet venting system composed of factory-built components assembled in accordance with the terms of listing to form a complete exhaust gas venting system.

The BLAZE KING Auto Light Model PAL-4001 and Model PAL-4200 pellet stoves use Z-Flex Model SF 2-inch bendable, stainless-steel liner (or 2 1/4-inch auto exhaust pipe for long, straight sections) installed inside the listed pellet vent to route exhaust gases out of the home. The space around the exhaust pipe, within the vent, acts as a combustion air inlet passage.

Installations may use any of several brands of listed, 4-inch "L" pellet venting systems.

Never vent your pellet stove into a "Class B" gas vent chimney.

SAFETY NOTICE

IF THIS STOVE IS NOT PROPERLY INSTALLED, A HOUSE FIRE MAY RESULT. FOR YOUR SAFETY, FOLLOW THE INSTALLATION DIRECTIONS. CONTACT LOCAL BUILDING OR FIRE OFFICIALS ABOUT RESTRICTIONS AND INSTALLATION INSPECTION REQUIREMENTS IN YOUR AREA.

PLEASE READ THIS ENTIRE MANUAL BEFORE YOU INSTALL AND USE YOUR NEW STOVE. FAILURE TO FOLLOW INSTRUCTIONS MAY RESULT IN PROPERTY DAMAGE, BODILY INJURY OR DEATH.

VENTING SYSTEM FIRE

In the event of a fire in the venting system:

1. Adjust the wall mounted thermostat to its lowest setting. If the thermostat is equipped with an "on/off" switch, turn the switch to the "off" position.
2. DO NOT turn off the electrical power nor unplug the stove. The circulating fans must still be allowed to operate.
3. Check the viewing door and ash door to be sure they are closed and securely latched.
4. Evacuate everyone from the house.
5. Call the fire department immediately.

A venting system fire can cause structural damage to the venting system. Have the entire system inspected by a building inspector, fire department official or certified chimney sweep. Do not use the stove until the system has been inspected and any damaged parts have been replaced.

Contact your fire department for further advice. Your family should have a prearranged plan so that each person will know what to do and will act immediately if such an emergency arises.

SMOKE DETECTORS

Install at least one smoke detector on each floor of your home to ensure your safety. It should be located away from the pellet stove and close to the sleeping areas. Locating a smoke detector too close to a stove can cause the smoke detector alarm to sound if a puff of smoke is emitted while the door is open. (DO NOT open the viewing door while the fire is burning.) Follow the smoke detector manufacturer's placement, installation and maintenance instructions. Your local fire department may provide assistance in selecting smoke detectors, or contact the Consumer Product Safety Commission, Washington, D.C. 20207.

FIRE EXTINGUISHERS

Every home should have at least one fire extinguisher. An approved "Class A-B-C" extinguisher should be mounted on the wall, near an exit and close to the stove — but not so close that accessibility to the extinguisher could be blocked by a fire. Your local fire department can advise you concerning the most appropriate location.

BUILDING AND FIRE CODES, PERMITS AND INSPECTIONS

The installation of this stove must comply with your local building and fire codes. Always contact your local building inspector and/or fire department before beginning the installation process. If required, obtain a permit before installation and have the completed installation inspected. Noncompliance with building and/or fire codes may jeopardize your homeowner's insurance.

CHILDREN

Do not allow children to play near the stove or with the operating knobs. Severe burns may be inflicted by touching the front, sides or top of the stove and by opening the viewing door. Train children to stay away from the stove and never leave children unattended in the room when the stove is in operation.

CLEARANCES TO COMBUSTIBLE MATERIALS

For a safe installation, proper clearances to combustible materials must be observed (see page 16). Failure to follow these guidelines voids the certification and warranty; is illegal; and can result in a fire causing property damage, injury or death. Keep combustible (burnable) materials at least as far away from the stove as the table on page 17 and 20 indicates. Combustible materials include items such as plasterboard or wood-paneled walls, furniture, wooden mantels, bookshelves, carpets and drapes. Pellet fuel should not be stored within the specified distances.

FUEL

CAUTION

THIS PELLET STOVE IS FOR USE WITH SOLID WOOD PELLET FUEL ONLY. DO NOT USE PELLETS THAT HAVE BEEN EXPOSED TO MOISTURE. DO NOT USE GASOLINE, GASOLINE-TYPE LANTERN FUEL, KEROSENE, CHARCOAL LIGHTER FLUID OR SIMILAR LIQUIDS TO START OR "FRESHEN UP" A FIRE IN THIS APPLIANCE. KEEP THESE FLAMMABLE LIQUIDS WELL AWAY FROM THIS APPLIANCE WHILE IT IS IN USE.

Do not burn cordwood in the pellet stove.

Do not burn materials soaked in flammable liquids, trash, garbage, artificial or paper logs, plastics, gift wrappings, coal, charcoal, naphtha, engine oil, chemical cleaners, chemical fire starters, treated or painted wood, saltwater driftwood, railroad ties, plywood, particle board. Do not burn sawdust, wood shavings or chips in this woodstove.

When selecting pellet fuel for the BLAZE KING pellet stove, purchase only wood pellet fuel that is absolutely dry. Fuel must have less than 1% bark/ash content, be no larger than 5/16 inch (0.8 cm) diameter and 1 inch (2.54 cm) long. Use of pellets with more than 1% bark/ash, will increase maintenance frequency, lower heat output and make more ash and pollution. In addition, use of low grade pellets may void the stove warranty.

Always store pellets off the ground and under cover. Damp or wet pellets may cause the auger system to jam, and may void the warranty.

CAUTION

DO NOT PLACE PELLET FUEL WITHIN THE STOVE'S MINIMUM CLEARANCES TO COMBUSTIBLE MATERIALS OR WITHIN THE SPACE REQUIRED FOR LOADING AND ASH REMOVAL.

ELECTRICAL POWER

Connect this unit to a properly grounded, 110-volt electrical outlet. Do not route the power cord in front of, or under, the stove.

DISPOSAL OF ASHES

Ashes should be removed from the stove only when the stove is cold. Ashes should be placed in a metal container with a tight-fitting lid. The closed container of ashes should be placed on a noncombustible floor or on the ground, well away from all combustible materials, pending final disposal. The ashes should be retained in the closed container until all cinders have thoroughly

cooled. Ashes should never be placed in wooden or plastic containers, or in paper or plastic bags, no matter how long the fire has been out. Coals have been known to stay hot for several days when embedded in ashes. If the ashes are disposed of by burial in soil or otherwise locally dispersed, they should be retained in the closed container until all cinders have thoroughly cooled.

Do not store other waste in the ash container.

CAUTION

CLOSE THE ASH DRAWER TIGHTLY AFTER CLEANING. THE ASH DRAWER MUST BE IN PLACE AND CLOSED DURING OPERATION. BE SURE THE ASH DRAWER FASTENER IS TIGHTLY SECURED BEFORE RESTARTING THE STOVE.

WARNING

REMOVE ASHES ONLY WHEN THEY ARE COLD. NEVER STORE HOT ASHES IN A GARAGE OR BASEMENT. HOT ASHES WILL GENERATE CARBON MONOXIDE AND/OR FLAMMABLE GASES. THESE GASES MAY CAUSE SUFFOCATION.

CHIMNEYS

Do not vent this appliance into a flue serving any other appliance. This appliance is not listed to vent through an manufactured or masonry chimney. Venting into an existing chimney (either masonry or manufactured) will negate your stove warranty and may endanger your family and home.

Do not vent this appliance into a "Class B" gas vent chimney.

This appliance is listed by Warnock Hersey International, Inc. only when vented through a listed, 4-inch diameter, pellet vent piping system through an outside wall. (See Section 7 for venting information.)

The pellet venting system may get extremely hot during use. Temperatures inside the venting system may exceed 2000 degrees Fahrenheit in the event of a venting system fire. To protect against the possibility of a house fire, the venting system must be properly installed and maintained. A thimble must be used when a connection is made through a combustible wall or floor.

CREOSOTE AND FLY ASH

While properly operated and maintained pellet stoves deposit minimal amounts of creosote in the venting system, fly-ash buildup is common. Periodic cleaning of the stove and venting system is required. See "Maintenance," beginning on page 35.

Inspect the venting system, including the combustion fan on the outside wall, at least twice each month during the heating season. Any evidence of fly ash accumulation must be removed. Fly ash, under the proper conditions, will burn. Creosote accumulation within the venting system or on the combustion air fan blades indicates your stove is not burning properly. The cause could be an improperly installed, adjusted or operated stove.

VIEWING DOOR

Do not operate your stove with the viewing door open. This stove is not designed or intended to be operated with the viewing door open. Do not leave your stove unattended when the door is not tightly closed. Leaving the door open AFTER the fire is well started will cause excessive smoke spillage into your home.

Do not operate your stove if either pane of ceramic glass is broken.

Check the viewing door gasket for deterioration at least twice each heating season. If replacement is required, refer to the instructions on page 37.

ASH DRAWER

The ash door, located on the bottom front of the stove, must be closed and latched when the stove is burning. Open the ash door only to remove ashes from the stove's interior. When preparing to do so, wait at least 1/2 hour or until the stove has sufficiently cooled before opening the door.

Check the ash door gasket for deterioration at least twice each heating season. Replace if needed. Refer to page 37 for instructions.

PELLET HOPPER LID

The pellet hopper lid must be left closed at all times, except when actually loading pellets.

After loading pellets into the pellet hopper, CAREFULLY CLEAN AND REMOVE ANY SPILLED PELLETS AND ALL DEBRIS SCATTERED ON TOP OF THE HOPPER. A pellet (or even a small piece of a pellet) caught under the pellet hopper lid will cause safety devices to prevent the stove from restarting.

***** SECTION 5 - SPECIFICATIONS *****

Tested to and complies with U.L. 1482.
 Listed by Warnock Hersey International, Inc.

	PAL-4001	PAL-4200
Maximum Heat Output - - - - -	40,000 Btu/hr (9,072 kilocalories)	
Fuel Capacity (Approximate) - - - - -	70 lbs. (32 kg)	65 lbs. (29 kg)
Maximum Pellet Size (diameter x length)	5/16" x 1" (0.8 cm x 2.5 cm)	
Total Weight (Approximate) - - - - -	380 lbs. (838 kg)	345 lbs. (760 kg)
Width - - - - -	31" (78.74 cm)	31" (78.74 cm)
Depth - - - - -	27" (68.58 cm)	26" (66.04 cm)
Height - - - - -	30" (76.2 cm)	37" (93.98 cm)
Circulating Fans - - - - -	2	
Firebox, steel thickness - - - - -	10 gauge (0.34 cm)	
Power consumption		
Maximum, with igniter ring on - -	600 watts	
Maximum, with igniter ring off - -	—	
Ceramic Door Glass		
Inner and outer panes - - - - -	5 mm x 8 1/8" x 10 5/8" (5 mm x 20.64 cm x 26.99 cm)	
Venting System - - - - -	4" listed "L" vent	
Maximum Horizontal Distance		
Stove to exhaust fan - - - - -	13' (3.96 m)	
Maximum Vent Length		
Stove to exhaust fan - - - - -	15' (4.57 m)	

No more than three elbows may be used in the venting system from the stove to the exhaust fan. Only one elbow may be used between the exhaust fan and the horizontal venting cap.

Horizontal vent runs require a 1/4" (0.64 cm) per foot (2.54 cm) drop from stove to fan. Horizontal or vertical vent runs must maintain a 3" (7.62 cm) clearance from vent to floor, walls, ceiling or other combustible materials.

INSTALLATION PREPARATION

WARNING

IMPROPER ASSEMBLY AND/OR INSTALLATION OF YOUR BLAZE KING PELLET STOVE, OR FAILURE TO OPERATE IT ACCORDING TO THE GUIDELINES DETAILED IN THESE INSTRUCTIONS, WILL VOID THE STOVE WARRANTY, CAN CAUSE A HOUSE OR CHIMNEY FIRE, AND MAY ENDANGER YOUR FAMILY. FOR YOUR SAFETY, FOLLOW THE ASSEMBLY AND INSTALLATION INSTRUCTIONS CAREFULLY. CONTACT LOCAL BUILDING OR FIRE OFFICIALS ABOUT RESTRICTIONS AND INSTALLATION INSPECTION IN YOUR AREA.

LISTING

BLAZE KING Auto Light Model 4001 and Model 4200 pellet stoves are listed by Warnock Hersey International, Inc. to U.L. 1482. The Warnock Hersey listing applies ONLY if: it is connected to a listed pellet stove venting system of the proper diameter; the venting system does not exceed the parameters described in this section regarding length, height and direction; only dry pellet fuel of accepted quality is used; and minimum clearances to combustible (burnable) materials are observed. (See this section, page 16 for minimum clearances.)

DO NOT CONNECT THIS UNIT TO A CHIMNEY FLUE SERVING ANOTHER APPLIANCE.

WARRANTY CARD

IF YOU HAVE NOT ALREADY DONE SO, PLEASE TAKE A FEW MINUTES TO COMPLETE THE WARRANTY CARD FOUND IN THE FIREBOX AND MAIL IT TODAY.

PRODUCT INSPECTION

Remove any items packed in the firebox. BLAZE KING stoves are known for their quality materials and construction. However, no one is perfect and mistakes occasionally occur. Inspect all parts for damage due to shipping and to be sure that all needed parts are enclosed. If you discover a part is missing or damaged, contact your dealer immediately for replacement or repair. Be prepared to give the dealer the model and serial number on your stove — both are found on the tag on the pellet hopper lid.

The stove and related components are packed in two boxes, the contents of which are listed below.

Quantity	Item
1	Owners manual
1	Trouble-shooting guide
1	Warranty card
1	Stove, flexible conduit attached
1	Exhaust fan assembly
3	Exhaust fan stand-off brackets
1	Wall thermostat
3	Wire nuts
1	Rodent screen
2	Room-air fan blades (packed separately, Model 4200 only)
1	Room-air fan screen (packed separately, Model 4200 only)

TOOLS NEEDED FOR INSTALLATION

If you are planning to install this stove yourself, you will need at least the tools listed below. Other tools may make the installation easier. Consult the manufacturer's installation instructions for tools needed when installing the thimbles and venting system.

- a. Hammer
- b. Screwdriver, flat blade
- c. Screwdriver, Phillips
- d. Electric drill with 7/8-inch bit
- e. Carpenters square
- f. Carpenters level
- g. Tape measure
- h. Saw - Manual keyhole saw will work, but an electric jigsaw will make the job easier.
- i. 7/16-inch wrench, or socket with handle
- j. 11/32-inch wrench
- k. 1/8-inch Allen wrench

ADDITIONAL SUPPLIES NEEDED

ALL INSTALLATION OPTIONS

Floor protector. Under stove and extending 2 inches (5 cm) each side, 12 inches (30.5 cm) in front and to walls behind stove.

4-inch pellet vent. Straight sections of various lengths, 45 and 90 degree elbows as needed.

4-inch pellet vent tee.

Pellet vent thimble. One will be needed to pass through the exterior wall; a second will be needed if the vent will be passing through the floor or a second wall.

Z-Flex Model SF 2-inch bendable, stainless-steel liner for elbows and short, straight sections.

2 1/4 inch automobile exhaust pipe for long, straight sections. Multiple sections of adequate length can be purchased from a muffler shop. If more than one piece is used, one must be flared at each joint so they can be connected. See figure 4, page 23.

Sheet-metal screws. At least two screws for each exhaust pipe joint and two for each "L" vent joint.

Red RTV 600-degree silicone. Quantity depends on number of joints. Can be purchased from an auto supply store.

Weatherproof silicone. Several tubes or an 11 oz. caulking-gun size. May be purchased at hardware or home supply store.

24 volt, four-conductor thermostat wire of adequate length. Can be purchased from home or electrical supply store.

1/2-inch flexible electrical conduit. Needed only if flexible conduit attached to back of stove is not long enough to reach exhaust fan. Total length of flexible conduit should be approximately the same as total "L" vent length. Will be cut to exact length.

Aluminum self-adhesive tape. Length sufficient for sealing each vent pipe joint inside residence (including pipe in basement or crawl space.) Use Polyken #237-2" or equivalent. Can be purchased from your BLAZE KING dealer.

Plumbers tape. Enough to support horizontal sections of pipe at each joint. Can be purchased from a home or plumbing supply store.

Lagbolts, bolts and nuts, or other fasteners. These must be used to mount the exhaust fan to the exterior wall and, in mobile home installations, to secure the stove to the floor. Can be purchased from hardware or home supply store.

FOR MOBILE HOMES: #8 ground wire of adequate length and suitable ground wire

clamps. Can be purchased from any home or electrical supply store.

FOR MOBILE HOMES, MODEL 4001 ONLY

Stove securing brackets. Use flat corner braces with minimum leg length of 4 inches. Available at hardware stores.

PLANNING FOR YOUR STOVE PLACEMENT

Consider the role of your new BLAZE KING Auto Light pellet stove in the total heating plan of your home. If your goal is to provide 70% to 100% of the total heat needs of your home, then place the stove in an open, central location.

If your stove will be used as a secondary heat source, a more remote placement is acceptable.

If you have a forced-air heating system, you can use the existing ducts and furnace fan to circulate air throughout the home. DO NOT connect the stove directly to the heating-system ducts or any other air-distribution ducts. Place the stove near a cold-air return duct.

Consider safety, convenience and traffic flow. The fact that the stove will need to be vented to the outside should be a primary consideration.

Also consider the need for electrical power and the position of the wall-mounted thermostat. Do not place the electrical power cord in front of, or under, the stove.

Review pages 16-20 for MINIMUM clearances. Allow space for the floor protector. Keep furniture, drapes, curtains, wood, paper, and other combustibles far away from the stove.

Never install the stove in locations where gasoline, kerosene, charcoal lighter, or any other flammable liquids are used or stored.

FLOOR PROTECTION

Floor protection material can be any non-combustible material or Listed Floor Protector. This floor protector covers the floor area underneath the stove and extends in front, to the sides and to the rear of the stove. The floor protector must extend 2 inches (5.08 cm) on each side of the stove base, 12 inches (30.48 cm) in front of the stove base and to the wall behind the stove.

When the listed pellet vent pipe does not extend back through the rear wall behind the stove, but goes another direction (up, down or sideways) the floor protector must extend to the wall under the venting system and must extend 2 inches (5.08 cm) beyond each side of the venting system. Read the installation instructions.

WARNING

FAILURE TO ALLOW THE REQUIRED CLEARANCES TO COMBUSTIBLE MATERIALS OR TO PROVIDE ADEQUATE FLOOR PROTECTION CAN CAUSE A HOUSE FIRE. SUCH A FIRE CAN RESULT IN DAMAGE TO PROPERTY AND SERIOUS INJURY OR DEATH.

CLEARANCES TO COMBUSTIBLES

The sides of this BLAZE KING pellet stove may not be placed closer than 3 1/2 inches (8.89 cm) to any combustible material. The back may not be placed closer than 6 inches (15.24 cm) to any combustible material. Clearances are measured from the edge of the stove base.

Minimum clearances to non-combustible materials are the same as the clearances to combustible materials mentioned in the preceding paragraph. The heat production capabilities and safety of this appliance depend on having free air space on all sides. Do not place it closer than the allowed clearances to any wall.

The listed pellet vent pipe system may not be placed closer than 3 inches (7.62 cm) to any combustible material. Due to the required 3-inch vent clearance, some installations (corners, for instance) may require that the stove be farther than 6 inches (15.24 cm) from combustibles. Do not place any combustible (including fuel) closer than 3 inches (7.62 cm) to the stove's sides or 6 inches (15.24 cm) to the stove's back. Combustibles should not be placed closer than 12 inches (30.48 cm) to the stove front.

Combustible materials include material made of or surfaced with wood, compressed paper, plant fibers, plastics, or other materials that will ignite and burn, whether flameproofed or not, or whether plastered or unplastered.

INSTALLATION OPTIONS

MINIMUM CLEARANCES TO COMBUSTIBLE MATERIALS

All clearances to combustibles -- whether to walls or to other materials -- are measured from the edge of the stove base nearest the floor, not the side of the stove.

INSTALLATION OPTIONS	A	B	C	D	E	F
1a Stove parallel to back wall, venting straight back through outside wall	NA	12" 30.48 cm	NA	6" 15.24 cm	3.5" 8.89 cm	NA
1b Stove parallel to back wall, venting through outside wall to right or left side	3" 7.62 cm	NA	NA	13" 33.02 cm	3.5" 8.89 cm	NA
1c Stove in corner at 45 degrees to walls, venting through outside wall to right or left side	NA	NA	3" 7.62 cm	NA	NA	3.5" 8.89 cm
1d Stove in alcove, parallel to back wall, venting straight out through outside wall	NA	12" 30.48 cm	NA	6" 15.24 cm	3.5" 8.89 cm	NA
2a Stove parallel to back wall, venting through floor, then out any outside wall	3" 7.62 cm	12" 30.48 cm	NA	13" 33.02 cm	3.5" 8.89 cm	NA
2b						
2c Stove in corner at 45 degrees to walls, venting through floor, then out any outside wall	NA	NA	3" 7.62 cm	13" 33.02 cm	NA	3.5" 8.89 cm

Figure 1

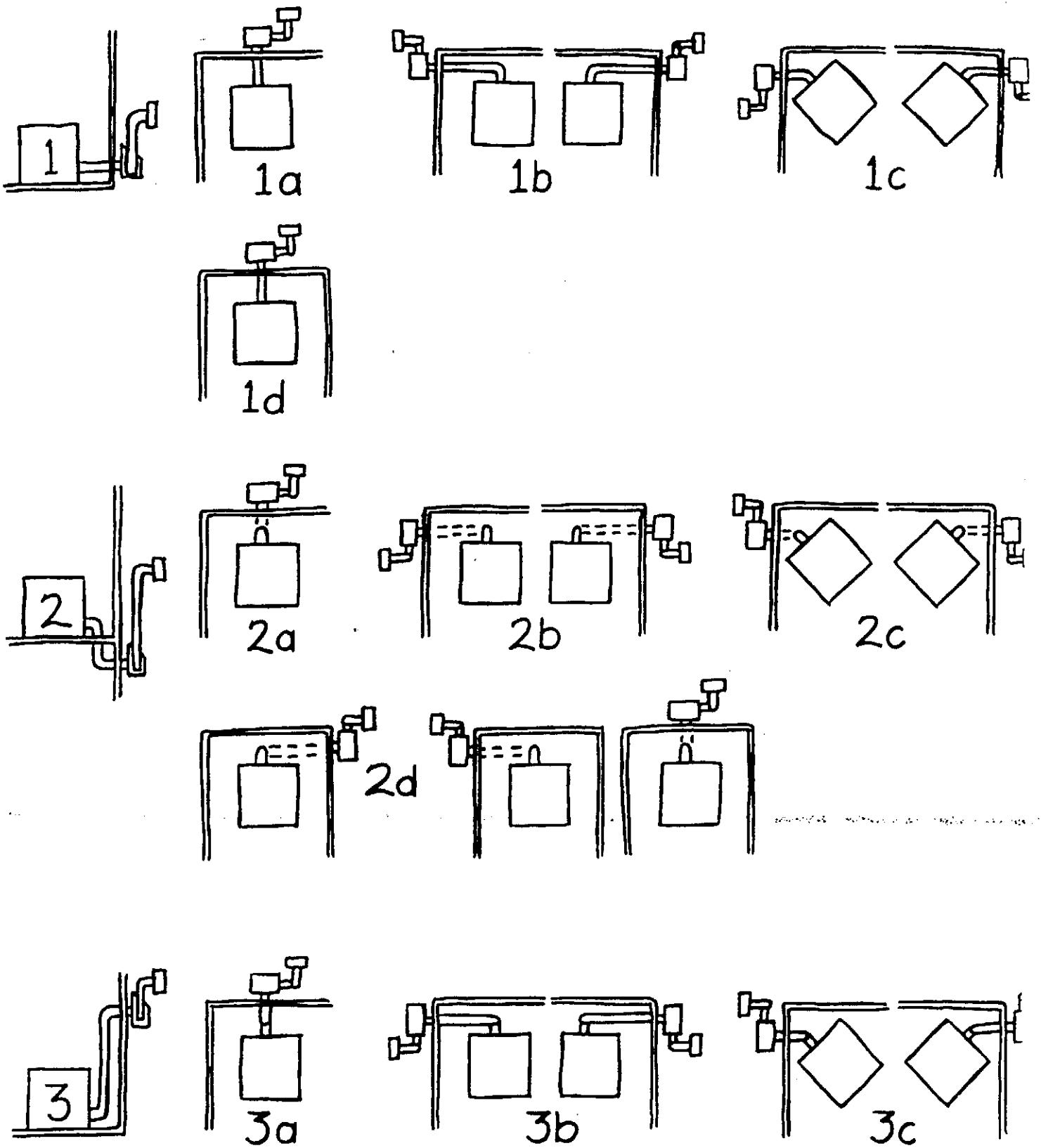
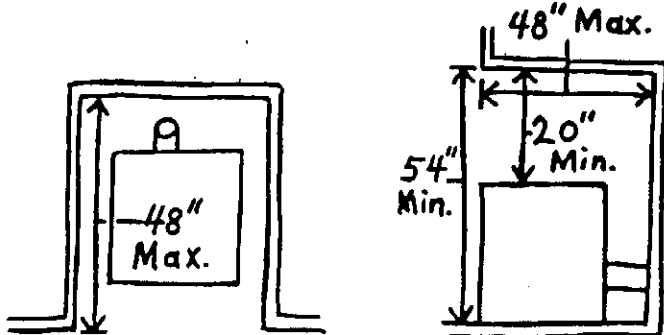
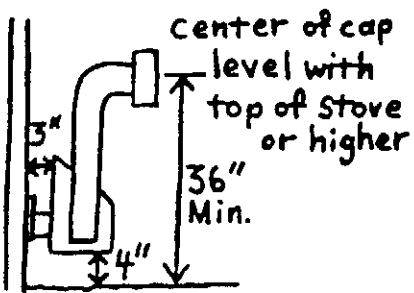
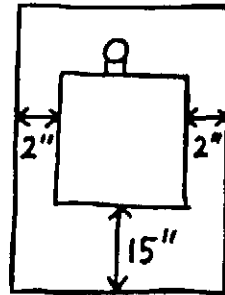
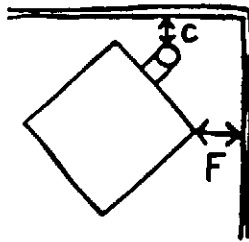
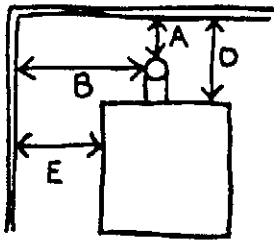

Figure 2



	A	B	C	D	E	F
2d Stove in alcove, venting through floor, then out any outside wall	3" 7.62 cm	12" 30.48 cm	NA	13" 33.02 cm	3.5" 8.89 cm	NA
3a Stove parallel to back wall, venting up, then out through outside back wall	3" 7.62 cm	12" 30.48 cm	NA	13" 33.02 cm	3.5" 8.89 cm	NA
3b Stove parallel to back wall, venting up, then out through outside wall to right or left side	3" 7.62 cm	NA	NA	13" 33.02 cm	3.5" 8.89 cm	NA
3c Stove in corner at 45 degrees to walls, venting up, then out through outside wall to right or left side	NA	NA	3" 7.62 cm	NA	NA	3.5" 8.89 cm

NOTE

For purposes of this installation manual, an alcove is defined as a recess or partly enclosed extension connected to, or forming a part of, a room. It may be on either an interior or exterior wall, no more than 48 inches (121.92 cm) deep, no less than 38 inches (96.52 cm) wide and no less than 54 inches (137.16 cm) from the top of the floor protection to the ceiling. The alcove ceiling must be at least 20 inches (50.8 cm) above the top of the Model 4001 and 15 1/2 inches (39.37 cm) above the top of the Model 4200.

GENERAL INSTALLATION NOTES

1. FOR CONVENTIONAL AND MOBILE HOME INSTALLATIONS, THIS BLAZE KING AUTO LIGHT PELLET STOVE IS LISTED TO BE INSTALLED WITH ANY LISTED, 4" "L" VENT, PELLET VENT PIPE SYSTEM.
2. ALL HORIZONTAL SECTIONS OF PELLET VENT MUST SLOPE DOWN TOWARD THE EXHAUST FAN AT A RATE OF 1/4 INCH (0.64 CM) PER FOOT.
3. PELLET VENT PIPE SYSTEM LIMITATIONS
 - A. Maximum total horizontal distance from stove to exhaust fan, 13 feet (3.96 m).
 - B. Maximum vent length from stove to exhaust fan, 15 feet (4.57 m).
 - C. The center of the horizontal venting cap must be level with top of stove or higher. Locating the horizontal venting cap below top of stove may allow exhaust gasses to enter living space through the hopper, if the lid is left open.
 - D. The horizontal venting cap must not be located inside a garage, under a carport or patio roof, or in any other location where an obstruction

above or beside the port could cause exhaust gases to collect. The exhaust fan may, however, be located in such positions if the horizontal venting cap is located outside of these areas.

- E. The horizontal venting cap must not be located near any shrubs, plants or other combustible material.

MOBILE HOME INSTALLATION NOTES

Some state or local jurisdictions may not allow the installation of pellet stoves in mobile homes. Contact local building or fire officials.

If this pellet stove is being installed in a mobile or manufactured home, horizontal exhaust vent terminations (the horizontal venting cap) shall be located not less than 4 feet (1.22 m) below, 4 feet (1.22 m) horizontally from, or 1 foot (30.48 cm) above any door, window or gravity air inlet into any building, nor less than 2 feet (60.96 cm) from an adjacent building, nor less than 7 feet (2.13 m) above grade when located adjacent to public walkways. If these distances cannot be met within the 15 foot (4.57 m) stove-to-fan length limitation, another location must be found for the stove.

WARNING
DO NOT INSTALL IN SLEEPING ROOM.

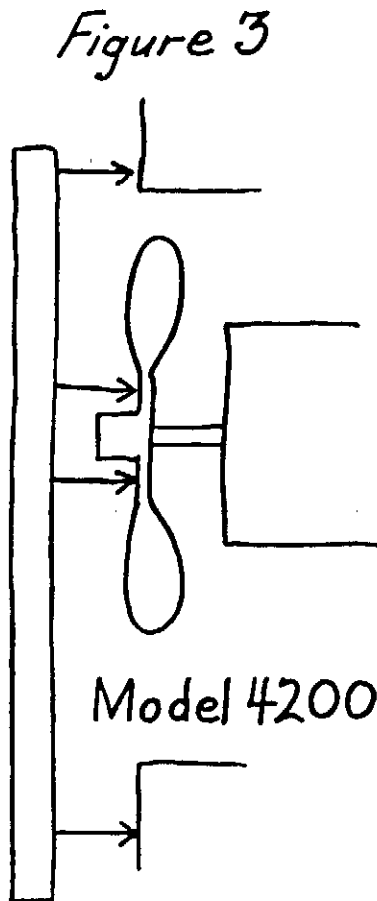

SAFETY NOTICE

IF THIS STOVE IS NOT PROPERLY INSTALLED, A HOUSE FIRE MAY RESULT. FOR YOUR SAFETY, FOLLOW THE INSTALLATION DIRECTIONS. CONTACT LOCAL BUILDING OR FIRE OFFICIALS ABOUT RESTRICTIONS AND INSTALLATION INSPECTION REQUIREMENTS IN YOUR AREA.

PLEASE READ THIS ENTIRE MANUAL BEFORE YOU INSTALL AND USE YOUR NEW STOVE. FAILURE TO FOLLOW INSTRUCTIONS MAY RESULT IN PROPERTY DAMAGE, BODILY INJURY, OR EVEN DEATH.

CAUTION

DO NOT PLUG IN THE STOVE UNTIL INSTRUCTED TO DO SO. CONNECTING THE STOVE TO AN ELECTRICAL POWER SOURCE BEFORE IT IS PROPERLY ASSEMBLED AND INSTALLED COULD RESULT IN ELECTROCUTION, INJURY AND/OR DAMAGE TO THE STOVE.

STOVE ASSEMBLY

1. A coil of flexible conduit (containing wiring for power to the stove's exhaust fan) is attached to the stove. Cut the ties holding the coil in place and allow the free end to lay on the floor. DO NOT disconnect the other end from the stove. If you have a Model 4001, the stove is now ready for installation. If you have a Model 4200, assemble it according to the following instructions before installing it.

2. Using an 11/32-inch wrench, unscrew the two nuts holding one of the fan motors to its mount. Remove the fan from the mount.

3. Turn fan motor around and remount it using nuts removed in step 2.

4. Install the left fan blade (marked with a green dot) on the left fan motor shaft (also marked with a green dot) with the blade's hub pointing away from the stove. To correctly position the fan blade, lay a straightedge across the back of the stove. Align the face of the fan (beside the hub) with the straightedge. See figure 3, page 21. Install the right fan blade (marked with a red dot) on the left fan motor shaft (also marked with a red dot), positioning the fan blade as previously described.

5. The Allen setscrew must seat on the flat spot on the fan motor shaft. Tighten the Allen setscrew using a 1/8-inch Allen wrench.

6. Repeat steps 1 through 5 to mount the other fan motor and blade.

7. Mount the fan screen using Phillips sheet metal screws.

VENT AND EXHAUST PIPE ASSEMBLY INFORMATION

This BLAZE KING Auto Light pellet stove employs a double walled, coaxial, venting system. The inner pipe carries the exhaust gasses from the stove to the

Figure 4

- ① Clean the inside of the stove's exhaust port and the outside of the exhaust pipe or flexible, stainless steel tubing.



- ② Coat inside of exhaust port with film of red RTV, 600-degree Silicone. Apply liberal amount of same silicone to outside of exhaust pipe. Insert exhaust pipe into stove's exhaust port. Rotate pipe 45 degrees.

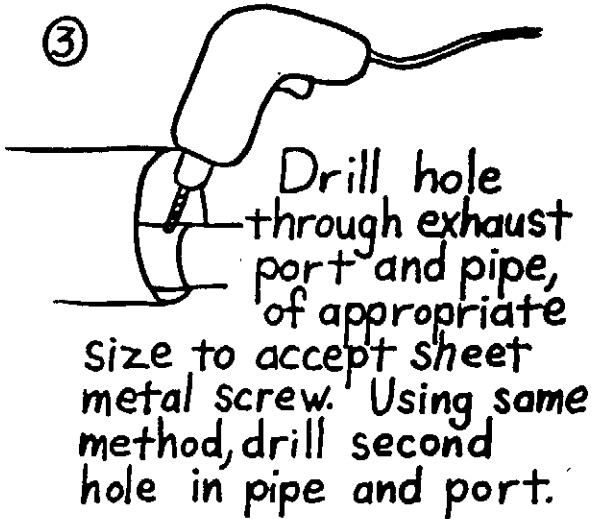

- ③ Drill hole through exhaust port and pipe, of appropriate size to accept sheet metal screw. Using same method, drill second hole in pipe and port.

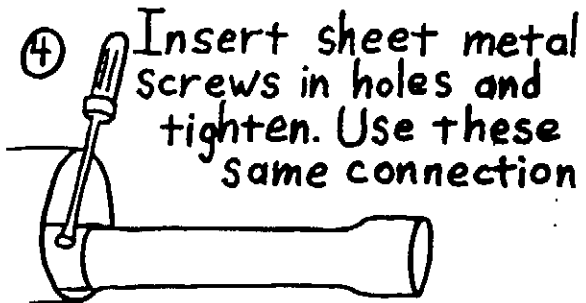

- ④ Insert sheet metal screws in holes and tighten. Use these same connection

- ⑤ Install the first section of pellet vent pipe on the stove's 4-inch air intake port. Attach it to this port using two screws and red RTV, 600-degree silicone just like you did with the exhaust pipe.

methods as you finish installing the exhaust pipe or flexible, stainless-steel tubing.

- ⑨ Wrap every pellet vent pipe joint inside the home with Polyken 237 aluminum tape or equivalent.

- ⑥ The rest of the pellet vent pipe must be locked together by rotating each new section clockwise. Apply silicone, lock in place by rotating clockwise, drill holes and install two sheet metal screws.

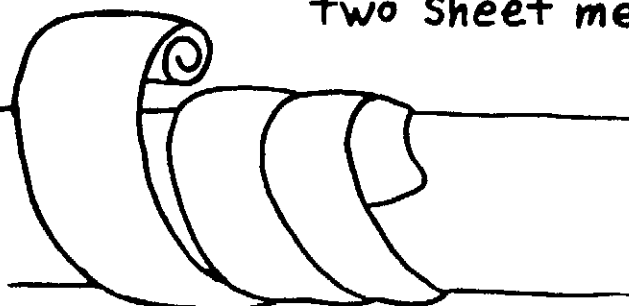

outside. Corners and short, straight sections of this inner pipe can be made using Z-Flex Model SF 2-inch bendable, stainless-steel liner (available from your BLAZE KING dealer). Long, straight sections can be made using 2 1/4-inch automobile exhaust pipe. The outer pipe is 4-inch (10.16-cm) listed "L" pellet vent. It provides insulation for the inner pipe and carries combustion air from outside of the home to the stove.

Both the exhaust pipe and the vent must be sealed at each joint with red RTV 600-degree silicone. Do not use household silicone caulk. Do not use your finger to apply the silicone to the exhaust pipe or tubing; the metal edges are sharp and can cut. Use a small, flat stick or other similar instrument.

The vent joints must also be wrapped with aluminum self-adhesive tape. Failure to seal all joints properly will result in poor stove performance and may endanger your home and family.

The vent is made to be self locking: When assembling, a clockwise, 15-degree twist of the pipe locks a section to the previous one. The sections must also be secured with at least two sheet-metal screws per joint.

Do not attempt to bend the listed "L" vent sections. Doing so could cause them to break. Do not connect the stove to the vent, then move the stove to adjust its position. Moving the stove after connecting the vent will apply stress to the vent and could damage it and will very likely break the seal at one or more of the joints. Measure carefully when planning your installation so that all straight sections of vent will be straight and all elbows will be 45 degrees or 90 degrees.

Neither auto exhaust pipe nor bendable, stainless-steel tubing are self-locking, and red RTV 600-degree silicone is not enough to hold the sections together. Each joint must be locked with at least two screws.

When straight sections of exhaust pipe are joined, one of the straight pieces must have a flared end so that the other piece can be slipped inside. The exhaust pipe also must be flared to allow the bendable, stainless-steel tubing to be slipped inside of it when the two are joined. All sections must be attached to each other with two screws, placed after those two sections are assembled and before the outer pellet vent pipe is in position. The bendable, stainless-steel tubing is bent as needed and vent pipe is installed over it.

All joints must be sealed with red RTV 600-degree silicone. Place a generous bead of this RTV silicone on the male section and apply a thin film of the silicone to the inside of the female section. Use enough silicone to create a positive seal.

WARNING

FAILURE TO SECURE AND SEAL ALL JOINTS PROPERLY WILL RESULT IN POOR STOVE PERFORMANCE AND MAY ENDANGER YOUR HOME AND FAMILY.

INSTALLATION INSTRUCTIONS

1. Determine the approximate location of the stove's venting system and where it will penetrate the home's wall (and floor for installation options 2 through 2e). Set the floor protector and stove in the desired location, observing the clearances printed in these instructions and on the label on the hopper lid.

2. Determine the exact location at which the vent will penetrate the floor or wall. Remember that all horizontal sections of the vent must slope downward away from the stove at a rate of 1/4 inch (0.64 cm) of vertical drop per foot of horizontal section and the outside of the vent must be at least 3 inches (7.62 cm) from any combustible material (including a wall or ceiling). If the venting system will be penetrating the floor, attach a 4-inch, 90-degree vent elbow to the stove to help you determine the appropriate location. Mark the location of

the center of the vent hole on the wall or floor protector.

NOTE

PELLET VENT SYSTEMS ARE MANUFACTURED IN A LIMITED VARIETY OF VENT SECTION LENGTHS. CONSIDER AVAILABLE SECTION LENGTHS (THE ACTUAL AS-CONNECTED LENGTH, NOT THE OVERALL LENGTH) BEFORE CUTTING HOLES IN FLOORS OR WALLS. SEVERAL PELLET VENT MANUFACTURERS PRODUCE ADJUSTABLE SECTIONS. IN SOME INSTALLATIONS, IT MAY BE POSSIBLE TO MIX AND MATCH DIFFERENT LENGTH SECTIONS OF VENT TO ACHIEVE THE DESIRED LENGTH OVERALL. DO NOT MIX VENT FROM DIFFERENT MANUFACTURERS.

3. Move the stove. If the vent will be passing through the floor, take careful measurements, then move the floor protector and transfer the mark you made on the floor protector to the floor.

4. On the mark, drill a small hole all the way through the floor or wall. If drilling through a wall, be sure to drill the hole at the proper slope (1/4 inch or 0.635 cm drop per horizontal foot). CHECK FOR HIDDEN WIRING OR PLUMBING INSIDE THE WALL OR UNDER THE FLOOR BEFORE DRILLING.

5. IF YOU DRILLED THROUGH THE FLOOR, GO TO STEP 5.a.
IF YOU DRILLED THROUGH THE WALL, GO TO STEP 5.b.

5.a. Go into the basement or crawlspace below the floor and check that the center of the hole is at least 5 inches (12.7 cm) from any floor joist or electrical or mechanical system component (such as a heating duct, electrical wiring, electrical conduit, etc.) If it is not, repeat steps 1. through 5., readjusting the stove's position to relocate the routing of the vent, while maintaining the proper clearances to combustible materials.

Following the thimble manufacturer's instructions, mark the floor for the thimble hole. Check that the intended hole location will not damage the integrity of the floor structure. Consult your local building inspector if in doubt. If you must adjust the stove's position to relocate the thimble hole, repeat steps 1 through 5.

In the basement or crawlspace, determine where the venting system will be routed and the exact location where the vent will penetrate the home's outside wall. Keep in mind the minimum vent section lengths and the radii of the elbows. The vent sections MUST NOT be cut. Remember that all horizontal sections of the vent must slope downward away from the stove at a rate of 1/4 inch (0.64 cm) of vertical drop per foot of horizontal section and the outside of the vent must be at least 3 inches (7.62 cm) from any combustible material (including a wall, ceiling or the bottom of the floor above).

Drill a small hole all the way through the wall. Be sure to drill the hole at the proper slope (1/4 inch or 0.64 cm drop per horizontal foot). CHECK FOR HIDDEN WIRING OR PLUMBING INSIDE THE WALL BEFORE DRILLING.

Go to step 5.b.

5.b. Go outside and locate the hole you just drilled. Measure the distance from that hole to grade level. The center of the hole must be at least 9 1/2 inches (24.13 cm) above grade. This will give the bottom of the fan housing a 4 inch (10.16 cm) clearance.

If the distance measured is less than 9 1/2 inches (24.13 cm), you may not be able to use this venting option. If you are using installation options 1 through 1e, you may be able to raise the stove by some means (such as using a thicker floor protector) in order to gain the necessary height.

Following the thimble manufacturer's instructions, mark the outside wall for

the thimble hole.

Check to be sure that the intended hole location will not damage the structural integrity of the wall. If it will, you may have to adjust the position of the stove, route the venting system to a different location or reinforce the wall. If in doubt, consult your local building inspector.

The venting system MUST slope downward away from the stove at a rate of 1/4 inch (0.64 cm) drop per foot of horizontal section. The venting system MUST NOT slope downward toward the stove.

If you must adjust the position of the stove or reroute the venting system, repeat steps 1. through 5., being sure to maintain the required clearances to combustible materials.

If the thimble hole will cause no structural problems and the distance from the center of the hole to the grade is 9 1/2 inches (24.13 cm) or greater, go to step 6.

6. Determine the exact length of the venting system from the stove to the outside fan housing. When taking measurements for pellet vent pipe, remember that the installed length of the pipe is actually SHORTER than the pipe's actual length, since the end of one section fits into the end of the next section. The installed length must not exceed 15 feet (4.57 m).

7. Determine the exact length of all horizontal vent sections. The sum of these horizontal sections should not exceed 13 feet (3.96 m). Measure only the horizontal sections; disregard any vertical sections when making this measurement.

8. Determine the position of the horizontal venting cap. The center of the venting cap must be at least 36 inches (91.44 cm) above grade and must be level with, or higher than, the top of the stove inside the home.

9. Determine the length (within 1/4 inch or 0.64 cm) of the last horizontal pipe run — from the stove or the last elbow to the fan. This length must be made from available pellet vent pipe sections. Measure the thickness of the wall, including any trim on the outside that the venting system must penetrate. Since the pellet vent sections are available in a limited number of lengths and the vent must protrude no less than 3/4 inch (1.91 cm) and no more than 2 1/2 inch (6.35 cm) outside the home's wall, it may be necessary to adjust the stove's position. Maintain the proper clearances to combustible materials when doing so. DO NOT CUT PELLET VENT SECTIONS. If you are routing the venting system through the floor (installation options 2. through 2.e.), repeat steps 1 through 5 if you must relocate the stove.

10. IF USING INSTALLATION OPTIONS 1 THROUGH 1e or 3 THROUGH 3e, GO TO STEP 21.
IF USING INSTALLATION OPTIONS 2 THROUGH 2b, GO TO STEP 11.

11. Cut the hole in the floor for the thimble, using the guide marks you made when performing step 5.b. Follow the thimble manufacturer's instructions.

12. Set the floor protector back into position and double check that it is correctly placed. From below the floor, trace the location of the hole onto the bottom of the floor pad.

13. Cut the hole in the floor pad and put it back in position.

14. Following the manufacturer's instructions, install the thimble in the floor. Seal between the floor and thimble with silicone weatherstripping caulk. Do this around both the top and bottom halves of the thimble. The home's vapor barrier

must be maintained.

15. Cut the hole in the wall for the thimble, using the guide marks you made when performing step 5.a. Follow the thimble manufacturer's instructions.

16. MOBILE AND MANUFACTURED HOMES ONLY. Though manufacturing methods vary, many mobile and manufactured homes have thin exterior wall skins. After cutting the wall thimble hole, examine the wall structure. Additional framing may be needed to provide adequate support for the fan housing and vent pipe. If in doubt, consult your building inspector.

17. Following the manufacturer's instructions, install the thimble in the wall. Check again that the vent pipe will slope downward at a rate of 1/4 inch (0.64 cm) vertical drop for each foot of pipe as it passes out through the wall. Seal between the thimble and wall with silicone weatherstripping caulk. Do this around both the interior and exterior halves of the thimble. The home's vapor barrier must be maintained.

18. With the stove and floor protector in position, lay out the entire outer vent pipe system (the listed pellet vent pipe) and assemble it in place, from the stove through the outside wall.

Remember that the vent must be at least 3 inches (7.62 cm) away from any combustible surface and that it must protrude from the outside wall at least 3/4 inch (1.91 cm) but no more than 2 1/2 inches (6.35 cm). DO NOT CUT THE VENT SECTIONS. Adjustments can be made by using different lengths of pipe sections.

19. Number the pieces of vent pipe in order, then disassemble.

20. Purchase any Z-Flex Model SF 2-inch bendable, stainless-steel liner needed for your installation from your BLAZE KING dealer. If your installation requires the use of auto exhaust pipe for long, straight runs, take the bendable, stainless-steel tubing (if needed) and the entire outer vent system to a local auto exhaust system (muffler) shop. Assemble the pieces, in order, and explain your needs. (The inner pipe must extend 3 1/4 inches (8.255) beyond the outside wall.) One pipe at each joint must have a flared end (see figure 4, page 23) so that the two pieces can be connected. Purchase the needed 2 1/4-inch (5.72-cm) auto exhaust pipe sections from the shop.

21. Clean the inside of the 2 1/4-inch (5.72-cm) exhaust port at the back of the stove. Coat the inside of this port with a thin film of red RTV 600-degree silicone. Coat the last 3 inches (7.62 cm) of the outside of the first section of pipe or bendable, stainless-steel tubing with a generous amount of red RTV 600-degree silicone, then insert it into the exhaust port.

22. Drill two holes through the port and the exhaust pipe and install 2 sheet-metal screws in the holes.

23. Apply red RTV 600-degree silicone to the 4-inch air intake port and to the first section of pellet vent, following the same procedure as for the exhaust pipe. Connect the first vent section to the stove's port.

24. Drill two holes through the vent and port, then install 2 sheet-metal screws in the hole.

25. Assemble the rest of the pellet vent and exhaust pipe system.

Using a generous amount of red RTV 600-degree silicone, coat the outside of each section of bendable, stainless-steel tubing and exhaust pipe where they

will be inserted into the flared end of the next section. Coat the inside of each flared end with a thin film of red RTV 600-degree silicone.

The ends of each section of exhaust pipe must be drilled to accept sheet-metal screws. The screws are inserted and tightened to lock the sections together.

Using the methods described above and in figure 4 (page 23), install each section of vent. Be sure to lock the sections together by rotating each new section clockwise before drilling and installing the sheet metal screws. Follow the pellet vent manufacturer's instructions for connecting the sections of pellet vent pipe.

The inner exhaust pipe need not be centered inside the outer pellet vent pipe; it may lie on the bottom of the outer pipe.

26. Horizontal sections of the pipe must be supported. Use plumber's tape or an equivalent to support horizontal sections at every joint of the outer pellet vent pipe.

27. Every joint of the pellet vent pipe inside the residence (including inside the basement or crawlspace) must be sealed. Tightly wrap each joint with Polyken 237 aluminum tape (an equivalent) in addition to using red RTV 600-degree silicone.

28. Follow the procedure outlined in steps 25 through 27 until you are ready to install the last automotive exhaust pipe or bendable, stainless-steel section. From outside the house, insert the last exhaust pipe section through the thimble and into the flared end of the installed exhaust pipe. Mark the exhaust pipe 3 1/4 inches (8.26 cm) from the outside surface of the thimble. Remove the exhaust pipe and cut it at the mark. Clean the ends of both exhaust pipe sections and apply red RTV 600-degree silicone. Connect the sections and tighten the locking screws.

29. Slide the pellet vent section through the thimble and lock it in place. Check to be sure it extends at least 3/4 inch (1.91 cm), but not more than 2 1/4 inches (5.72 cm), past the outside surface of the thimble. **DO NOT CUT THE VENT.** The pellet vent must terminate at least 3/4 inch (1.91 cm) from the fan housing.

30. Slip the rodent screen over the exhaust pipe and push it snugly against the pellet vent pipe.

31. Remove six screws from the exhaust fan housing lid and remove the lid. Clean and coat the last inch of the exhaust pipe with red RTV 600-degree silicone, then place the fan unit over the exhaust pipe. Allow the exhaust pipe to lie on the bottom of the pellet vent pipe. The exhaust pipe does not need to be centered in the pellet vent pipe.

32. Mount the exhaust fan securely to the wall using the 3 brackets provided. See figure 5, page 29. Mounting methods will vary depending on the construction of your house.

33. The flexible conduit attached to the rear of the stove contains the power wires for the exhaust fan. This flexible conduit must be routed through a 7/8-inch (22 mm) hole in the wall (and in the floor in some installations). The flexible conduit must attach to the 90-degree conduit connector on the side of the exhaust fan housing. It must be long enough to form a drip loop (see figure 6, page 29). If it is not long enough, consult your local electrical inspector about the proper methods of extending the wiring. Such additional wiring must meet the National Electrical Code. Determine the best route for the conduit.

Figure 5

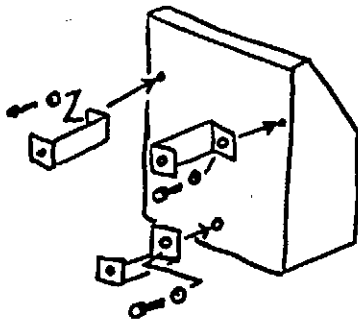

Select fasteners appropriate for use with your home's walls.

Figure 6

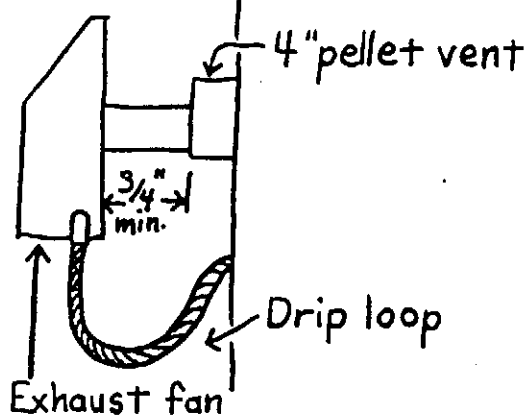

Figure 7

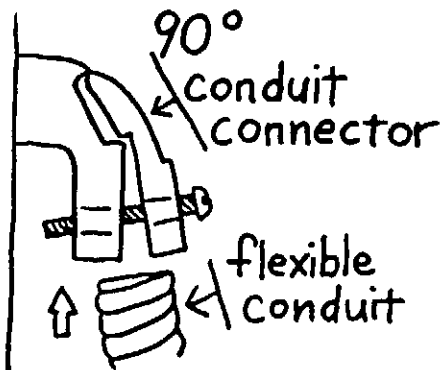

Figure 8

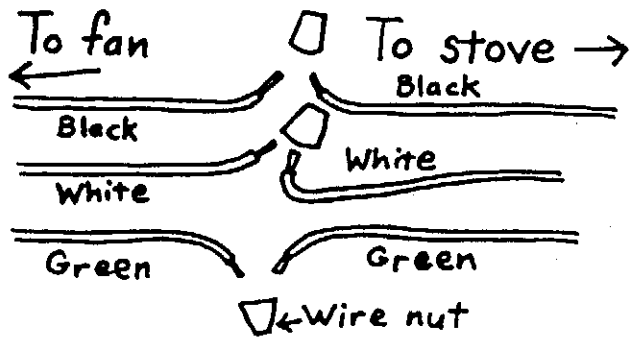

Figure 9

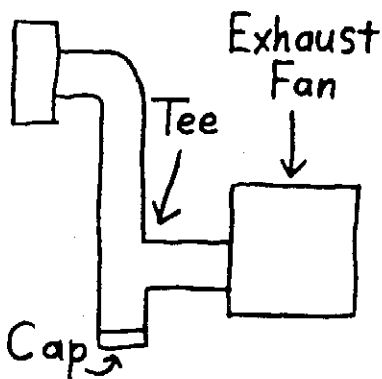
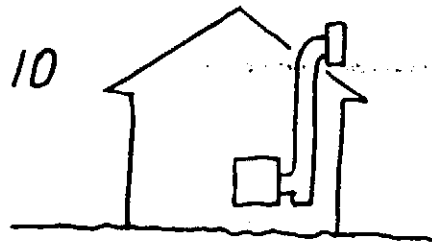

Figure 10



Check to see that the holes you intend to drill will not damage the structural integrity of the structure or damage any wiring, ducting or other component in the wall or floor. If in doubt, consult your local building inspector.

CAUTION

CONNECT THE EXHAUST FAN TO THE WIRING IN THE FLEXIBLE CONDUIT ATTACHED TO THE BACK OF THE STOVE ONLY. DO NOT CONNECT THE EXHAUST FAN DIRECTLY TO A 110-VOLT POWER SOURCE. CONNECTING THE EXHAUST FAN DIRECTLY TO A 110-VOLT POWER SOURCE OR TO ANY POWER SOURCE OTHER THAN THE FAN POWER WIRING EXTENDING FROM THE BACK OF THE STOVE WILL VOID THE PELLET STOVE WARRANTY AND MAY DAMAGE YOUR STOVE, CAUSE SMOKE AND/OR FIRE DAMAGE TO YOUR HOME AND ENDANGER YOUR FAMILY.

34. Drill the 7/8-inch (22 mm) hole (or holes) needed for the flexible conduit.

35. Route the conduit through the holes. Use silicone weatherstripping caulk to seal around the conduit.

36. Insert the wires in the conduit through the 90-degree conduit connector on the side of the exhaust fan housing. Loosen the two screws on the conduit connector to open the end of the fitting (see figure 7, page 29). Insert the flex conduit in the fitting and clamp it in place by tightening the screws.

37. Strip the last 1/4 inch (6.35 mm) of insulation from the fan cord wires and the exhaust fan wires. Connect the wires as shown in figure 8, page 29. While holding each pair of wires together, twist a wirenut over them in a clockwise direction until the nut is tight.

38. Replace the lid and secure it using the 6 screws removed in step 31.

39. Complete the vent system by connecting the exhaust fan housing to the horizontal venting cap using 4-inch (10.16-cm) vent. A tee (with the third outlet capped) must be used at the exhaust fan outlet port to facilitate ash removal (see figure 9, page 29).

The center of the horizontal venting cap exit port must be at least 36 inches (91.44 cm) above grade and at least as high as the top of the stove inside the home. The horizontal venting cap should also be at least 36 inches from any obstruction, such as shrubs, garbage cans, etc. If the exit port is located in a corner or on the windy side of the home, exhaust can accumulate to dangerous levels. In such situations, extend the exhaust vent to above the home's eaves to route the exhaust gases above the home (See figure 10, page 29).

If the exit port's position meets these requirements, finish by attaching a 4-inch listed pellet vent tee and a horizontal venting cap to the fan housing.

If the distance from the grade to the center of the fan exit port is less than 36 inches (91.44 cm), below the top of the stove, or obstructed, use a 4-inch listed pellet vent section, tee and a 90-degree elbow to raise the horizontal venting cap at least 36 inches (91.44 cm) above grade.

Whether the vertical pellet vent section is short or long, it must be terminated using a tee or 90-degree elbow and a horizontal venting cap.

MOBILE AND MANUFACTURED HOMES INSTALLATIONS ONLY: Restrictions applying to the placement of the horizontal venting cap must be observed. See page 21 for a list of placement restrictions.

40. If this unit is being installed in a mobile home, the exhaust fan box must be grounded. Codes may vary. Ground the fan box according to local codes.

Figure 11

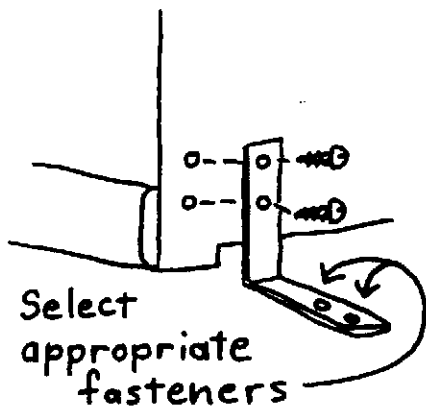

Figure 12

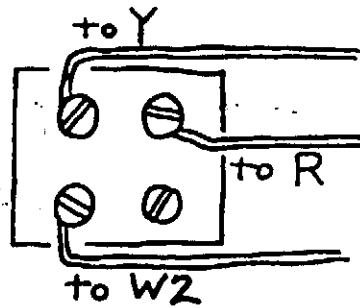
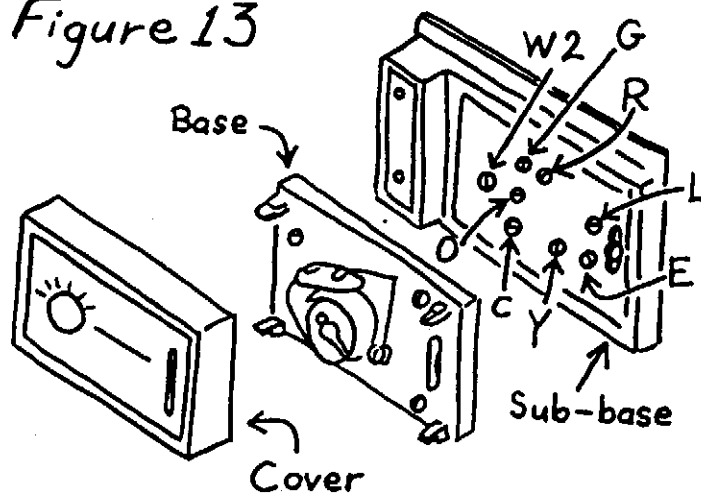

Figure 13



Terminals G, L, E, O and C are not used but must be tight to maintain electrical continuity.

41. If this stove is being installed in a mobile home, the stove must be fastened to the floor.

For a Model 4001, use wood screws to attach 4-inch, L-shaped, flat corner braces to the back of the stove (see figure 11, page 31). The braces may be attached to the floor using lag bolts or bolts, nuts and washers. (This hardware is available at most hardware and home-supply stores). Using the braces as a guide, drill holes for the fasteners in the back of the stove cabinet and in the floor, then fasten the stove in place according to local codes.

To fasten a Model 4200 stove to the floor, first remove the ash drawer, then remove the four screws from the front panel on the stove's base. Remove the panel. Insert a bolt through the hole near the center of the base, inside the pedestal, and attach the stove to the floor according to local codes.

42. If this stove is being installed in a mobile home, the stove must be grounded to the mobile home's frame. A grounding stud is located next to the electrical connection panel on the rear of the stove. Attach a grounding wire to the stove and to the mobile home's frame, using a method which meets local codes.

43. The wall-mounted, 24-volt thermostat may be placed anywhere in the home, but it is probably best located in the room with the stove.

If the stove is installed in an alcove, the thermostat should NOT be mounted within the alcove.

The thermostat should NOT be mounted closer than 15 feet (4.57 m) to the glass on the stove front. Radiant heat transmitted through the glass may cause the thermostat to indicate that the room is warmer than the room's actual temperature.

The thermostat may be as close as 24 inches (60.96 cm) to either side of the stove or to its back, as long as it is not mounted in an alcove with the stove.

Follow the instructions packed with the thermostat to mount the thermostat sub-base to the wall.

44. To connect the thermostat wiring, first strip the last 1/4 inch (6.35 mm) of insulation from the wires and form the bare ends of the wires into hooks. Follow figure 12 on page 31 to connect the wires to the terminals on the thermostat sub-base and the junction block on the back of the stove. Insert the hook of each wire under the proper connection screw and tighten the screw to clamp the wire in place. Most thermostat wire sets consist of four wires: black, white, red and green. You will not need the green wire.

45. After connecting the thermostat wires, finish assembling the thermostat by placing the thermostat base in position and tightening the six captive terminal screws (see figure 13, page 31).

45. Have a qualified installer inspect the thermostat and exhaust fan wiring. Have your stove installation inspected by a local building and/or fire inspector.

46. Plug the stove power cord into a properly grounded, 110-volt AC power outlet. Do not route the power cord under or in front of the stove.

47. For instructions on starting and operating your Auto Light Pellet Stove, see section 8, page 33.

CONTROLLING THE STOVE

Your BLAZE KING Auto Light Pellet Stove has only two controls: A wall-mounted thermostat to turn the stove on and off as your home needs heat; and a fuel-feed-rate selector knob on the side of the stove, which governs how fast the pellet fuel is fed into the stove. There are no other controls.

Unlike most stoves, the Auto Light can turn itself completely off when heat is not needed, then rekindle the fire when the thermostat signals a need for heat. The keys to this feature are the two-stage thermostat and the igniter ring (located in the firepot). When the thermostat indicates that heat is needed, the igniter ring lights the pellets in the firepot and the stove maintains that fire by feeding pellets into the firepot at a rate controlled by the position of the fuel-feed-rate selector knob. If the room temperature rises a few degrees above the temperature you've chosen, the thermostat tells the stove to "idle," that is, decrease the fuel-feed rate to a very slow speed. If the temperature continues to increase, the thermostat tells the stove to stop feeding pellets to the firepot and the fire will go out. When the thermostat senses that the temperature has dropped and heat is again needed, it tells the stove to start up again. The igniter ring lights the fuel and the stove again feeds pellets into the firepot.

At its slowest setting (position 1), the fuel-feed-rate selector allows about 1.5 pounds (0.7 kg) of pellets to be fed per hour. At its fastest setting (position 5), it allows about 5.8 pounds (2.63 kg) of fuel per hour. When the stove is "idling" (with the feed-rate selector in any position), it only burns approximately 0.7 pounds (0.32 kg) per hour.

The secret of getting the highest efficiency and cleanest burn from your pellet stove is to set the fuel feed at the optimum feed rate that will keep your home comfortable.

After the stove is installed, the thermostat connected and the hopper filled with pellets, begin startup by setting the feed-rate selector to high. When the fire starts, turn the feed-rate selector to the low setting and leave it. As long as your home stays warm, don't change the fuel-feed setting. Do not use the "Auto-Clean" setting continuously for low heat.

If the stove cannot keep your home warm enough, turn the feed-rate selector to the next higher setting and leave it for several hours. If it becomes evident that the house is still not as warm as you would like, turn it to the next highest setting and leave it for several hours.

There may be times when you will need to set the feed rate at its highest setting. This is acceptable. But don't set it on high if the stove continuously and quickly cycles on and off.

When the feed-rate selector is set higher than needed -- that is, when more heat is being generated than your home can use -- the stove will turn off and on. Every time the stove cycles off and on, efficiency is lowered.

Consider the extreme case: With the feed-rate selector at the highest setting and warm spring weather (little heat needed) the stove will burn hot and produce lots of heat quickly. The wall thermostat will turn the stove off and the home will slowly cool. When the thermostat says more heat is needed, the stove will relight and again produce more heat than is needed.

This quick cycling decreases efficiency and may contribute to a dirty exhaust tube, which will then require frequent cleaning.

THE FIRST FIRE

The BLAZE KING Auto Light is simple to start the first time.

First, make sure the venting system is properly installed, all electrical connections are finished, the wall thermostat is connected to the 24-volt thermostat terminals and the stove is plugged into a 110-volt AC outlet. Check

to be sure the viewing door and ash drawer are securely closed.

Open the pellet hopper lid on the top of the stove and dump a half sack of dry, clean pellets of the proper specifications into the hopper.

The stove is equipped with a safety switch to shut off the stove before it runs out of fuel. This switch is located under a flap in the pellet hopper on the stove's left side (the side on which the feed-rate knob is located). If pellets become lodged under the flap, the stove will not operate. To prevent this from happening, check under the flap before loading more pellets. Finish filling the pellet hopper. Clean any spilled pellets and debris from the top of the hopper and close the lid.

Set the fuel feed-rate selector control on the side of the stove to the highest number (fastest feed rate).

Set the wall thermostat at least 5 degrees Fahrenheit (3 degrees Celsius) above the existing room temperature. Pellets will be fed into the firepot. When pellets cover the igniter ring, turn the feed-rate selector to the Auto-Clean position. The igniter will come on and will start the fire.

When starting with a brand new, empty stove, this procedure should take no longer than 20 minutes. When starting with a cold stove that has previously been burned and has pellets in the fire pot, the time-to-light should be less than 7 minutes. After the fire has started to warm up the stove, the convection fans will automatically start and the igniter will shut off.

At any fuel-feed rate, pellets must cover the igniter ring before the fire will start.

RELOADING

Pellets may be placed in the pellet hopper at any time. Opening the pellet hopper lid will cause the stove to stop feeding pellets to the firepot. If the lid is left open, the fire will eventually go out. Closing the lid will allow the stove to relight itself.

AUTO-CLEAN

The self-cleaning position on the fuel feed-rate selector should be used periodically to keep the burn pot and igniter ring clean.

About once a week during the seasons when the stove is burning more or less constantly, turn the selector to the Auto-Clean position. Leave it at that position for two to four hours. This allows the fire to burn very low, and burns off deposits. Failure to perform this procedure may result in a stove that may no longer burn hot enough to keep your home warm; may burn dirty, requiring frequent cleaning of the exhaust system; and may no longer ignite.

***** SECTION 9 - MAINTENANCE *****

AUTHORIZED SERVICE REPRESENTATIVE

Your local BLAZE KING dealer is your authorized service representative. Should you have any problems with operating or maintaining your BLAZE KING pellet stove, contact him as soon as possible. The dealer will help you solve operating problems, provide replacement parts and/or arrange warranty service repairs as required. Dealers will need information such as model, serial number, date of purchase, and a summary of the problem.

VENTING SYSTEM FIRE

In the event of a fire in the venting system:

1. Adjust the wall mounted thermostat to its lowest setting, thereby turning the stove off.
2. DO NOT turn off the electrical power nor unplug the stove. The circulating fans must still be allowed to operate.
3. Check the viewing door and ash door to be sure they are closed and securely latched.
4. Evacuate everyone from the house.
5. Call the fire department immediately.

A venting system fire can cause structural damage to the venting system. Have the entire system inspected by a building inspector, fire department official or certified chimney sweep. Do not use the stove until the system has been inspected and any damaged parts have been replaced.

Contact your fire department for further advice. Your family should have a prearranged plan so that each person will know what to do and will act immediately if such an emergency arises.

CREOSOTE

When wood burns slowly (whether logs, split kindling or wood pellets) it produces tar and other organic vapors which combine with moisture to form creosote. Wood pellets burn exceptionally well and produce very little creosote. But, during each startup period, a little creosote is produced. When ignited, this creosote makes an extremely hot fire.

This BLAZE KING pellet stove should cause very low levels of creosote accumulation if it is operated properly. The frequency of start-up operations and the temperatures at which the stove is usually operated will affect the rate of accumulation. If significant creosote buildup occurs, check the thermostat settings and fuel feed rate settings. Review page 33 "Controlling the Stove."

The exhaust fan and venting system should be inspected at least twice each month during the heating season to determine if a creosote buildup has occurred. Check the system at the stove end and at the horizontal venting cap. If creosote has accumulated, it should be removed to reduce the risk of a fire.

The creosote should be removed with a brush specifically designed for the size and type of pipe in use. A chimney sweep can perform this service. It is also recommended that before each heating season the entire system be professionally inspected, and cleaned and repaired if necessary.

FLY ASH

When burned, wood pellets also produce fly ash. Fly ash may accumulate on the blades of the exhaust fan. (A heavy fly ash coating will reduce the stoves efficiency and result in a much dirtier burn.) Inspect the fan blades at least twice each month during the heating season. Any fly ash accumulation should be wiped or brushed off.

Most of the fly ash lands in the stove's ash pan, but some collects on the inside of the stove.

To inspect and clean the chamber inside the stove, allow the fire to go out and the stove to cool down. Open the viewing door and carefully wipe the entire inside surface of the firebox with a rag. Most of the fly ash will fall into the ash pan.

EMPTYING ASH DRAWER

Ashes should be removed from the stove only when the stove is cold.

1. If you have a Model 4001, remove the oak drawer panel from the bottom front of the stove. It is secured by two magnets. The Model 4200 does not have drawer trim.

2. Both models have an ash drawer that is clamped in place with a rotating handle/clamp. Lift the handle up and turn it 90 degrees in either direction.

3. Withdraw the ash drawer from the stove and empty it. Ashes should be placed in a metal container with a tight fitting lid. The closed container of ashes should be placed on a noncombustible floor or on the ground, well away from all combustible materials, pending final disposal. If the ashes are disposed of by burial in soil or otherwise locally dispersed, they should be retained in the closed container until all cinders have thoroughly cooled.

Do not store other waste in the ash container.

4. Replace the ash drawer, clamping it securely with the handle/clamp.

CAUTION

Close the ash drawer and tighten its fasteners securely after cleaning. The ash drawer must be in place and closed during operation. Be sure the ash drawer latch is tightly secured before restarting the stove.

5. If you have a Model 4001, reinstall the oak drawer panel.

INSPECTING AND CLEANING EXHAUST FAN

1. Turn off stove and unplug stove's power cord from wall outlet.

2. Remove the cap on the vent tee at the exhaust fan exit port and look into port. If there is an 1/8-inch (0.32-cm) or thicker accumulation of creosote and/or ash, you must disassemble and clean the fan (go to step 3). If not, reinstall the cap and plug the stove's power cord into a properly grounded, 110-volt outlet.

3. Remove the vent from the exhaust fan exit port.

4. Wait a half hour or until the exhaust fan has sufficiently cooled.

5. Remove 6 screws from exhaust fan housing lid and remove lid.

6. Disconnect electrical power from the fan by removing the plug from the receptacle in the fan housing.

7. Remove 5 sets of nuts and bolts attaching fan to housing. Remove fan.

8. Clean ash and creosote off fan blades and the inside of the fan. **DO NOT BEND FAN BLADES.** Check the condition of the gasket located between the fan and the fan housing (see figure 14, page 37). Replace the gasket if it is damaged or in poor condition.

9. Reattach the fan to its housing using the nuts and bolts removed in step 5. Some models may have a grounding wire fastened under one of the bolts. If your fan is so equipped, be sure to reattach the wire.

10. Plug the fan's power cord into the receptacle inside the fan housing.

11. Replace the fan housing lid and reattach using the screws removed in step 4.

12. Replace tee at the exhaust fan exit port.

13. Plug the stove's power cord into a properly grounded, 110-volt AC outlet.

Figure 14

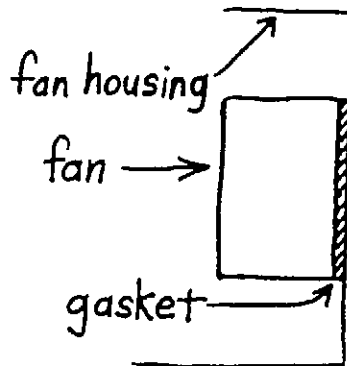

MAINTAINING GASKETS

Safe and efficient operation of any pellet stove depends greatly on the integrity of the gaskets. Check the viewing door, ash drawer and pellet hopper lid gaskets at the beginning of the heating season and at least twice during the heating season. When the gaskets are frayed or no longer seal, they must be replaced (contact your dealer for appropriate replacement gaskets). Inspect each gasket for physical deterioration, missing sections or obvious leakage. To check the gasket further, insert a piece of paper into the door opening, then close and latch the door. Try to pull the paper out. If the paper comes out, the gasket is loose and should be replaced. Repeat this check several times around the perimeter of each door.

If any of the gaskets need replacing, contact your BLAZE KING dealer.

CLEANING VIEWING DOOR GLASS

While the glass may coat with fly ash, cleaning is usually easy. Wiping with a soft cloth will remove most of the deposit. Manual glass cleaning should be done when the stove and glass are cool. **DO NOT CLEAN THE GLASS WHILE IT IS HOT.** Use a soft cloth and **NON-ABRASIVE** household cleaner. After using any cleaner, thoroughly rinse the glass with water to remove any deposits left by the cleaner. Failure to remove all traces of glass cleaner will result in the glass cleaner residue baking on. This residue will then be very difficult to remove.

VIEWING DOOR GLASS REPLACEMENT

Your BLAZE KING pellet stove is equipped with a door which uses two pieces of glass. Both are a strong, heat-resistant ceramic glass able to withstand extremely high temperatures and tested for continuous use above 1200 degrees Fahrenheit (650 degrees Celsius). However, this glass can be broken through improper use. If glass replacement becomes necessary, use only BLAZE KING part number 8435AA for glass on the outside of the door, and 8434AA for glass on the inside of the door (closest to the fire). **DO NOT SUBSTITUTE ANY OTHER MATERIAL FOR THIS PURPOSE.**

WARNING

BROKEN GLASS IS SHARP. ALWAYS WEAR EYE PROTECTION AND PROTECTIVE GLOVES WHEN HANDLING GLASS. DISCARD THE GLASS IN A CLOSED CONTAINER INACCESSIBLE TO CHILDREN.

1. Turn the wall thermostat to the lowest setting. Allow the fire to burn out and the stove to cool down.
2. Open the viewing door and remove it from the hinge pins by lifting up.
3. Remove the twelve #10 x 3/8 inch screws holding the retainers to the inside of the door.
4. Remove the damaged glass and the old glass gasket.
5. The replacement glass on the inside (facing the fire) has the gasket installed on its outer perimeter. The glass for the outside (facing the room) does not have a gasket installed, but comes with a silicone rubber gasket which must be placed between the glass and the door, in the same position as the old gasket. If replacing the outside glass, be sure the words "BLAZE KING" etched in the glass reads correctly when the door is closed.
6. Install both panes of glass, then reinstall the retainers with the #10 x 3/8 inch round head screws.

MAINTENANCE SCHEDULE

Every week (or more often as needed).

Set feed rate selector to Stay Clean setting for 2 to 4 hours.

Clean firepot, air tube holes and combustion chamber.

Empty ash drawer.

Every month (or more often as needed).

Clean exhaust fan blades and housing.

Twice during each heating season.

Check the viewing door, ash drawer and pellet hopper lid gaskets.

OM18B
ED-12/89

OWNER'S
INSTALLATION AND OPERATION INSTRUCTIONS

BLAZE KING
WOODSTOVES

Auto Light Pellet Stoves
Models PAL-4001 and PAL-4200

BLAZE KING
3301 EAST ISAACS
WALLA WALLA, WA 99362
509/529-9820

SAVE THESE
INSTRUCTIONS

Copyright © 1989 Western Fab & Finish, Inc.