

Blaze King®

OWNER'S
INSTALLATION AND OPERATION
INSTRUCTION
BOOK

FOR RESIDENTIAL INSTALLATION
BLAZE PRINCESS, TOP VENT
PF-202 and PFJ-202

BLAZE KING® WOODSTOVES FOR RESIDENTIAL INSTALLATION INSTALLATION AND OPERATION INSTRUCTIONS

You are now the proud owner of a Blaze King® woodstove—the finest, most beautiful wood stove ever introduced in America.

It is the desire of Woodcutters Mfg., Inc. that your stove give you a lifetime of trouble-free operation. We suggest that before starting installation you read these installation and operating instructions.

Warranty

To register your warranty, fill out and return the "Warranty Card" packed with these instructions in the firebox of the stove.

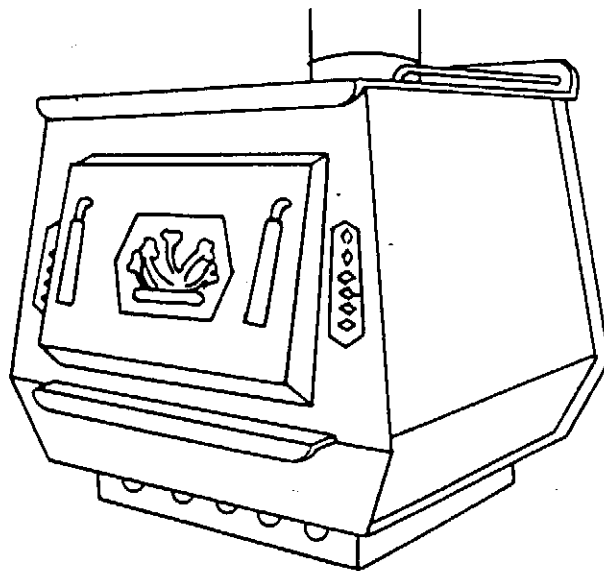

FIG. 1

Test and Certification

PF-202 and PFJ-202 Gas Appliance Laboratory Test Report #79.04.12A for approval as ICBO Report #3634.

Dimensions

Model	Width	Depth	Height	Weight (lbs.)
Blaze King Princess PF-202	26"	31"	29"	265
PFJ-202	26"	33"	29"	275

Product Inspection

First, remove all packaged parts from your stove and inspect them. Make sure that the stove is complete. Examine the pieces to see that there is no damage caused by shipping. Should any part be missing or damaged, contact your dealer.

Check List

1. Stove with firebrick installed.
2. Door with gasket material installed.
3. Wood handles.
4. Blower motor and screws (on Jet-Air models).
5. Fireplace screen with handle and hardware.
6. Thermostat knob.
7. Smoke shelf.
8. Ceramics—center and sides. (Side ceramics for Jet-Air models must have air holes.)

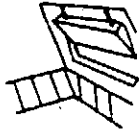

FIG. 2



FIG. 3

Important

Improper installation of your Blaze King® woodstove, or failure to operate it according to the guidelines detailed in these instructions, may negate your Warranty and endanger your home and family.

For years of carefree, efficient heating, follow building and fire codes during installation and consult these instructions when operating your Blaze King® woodstove.

Some Cautions

1. Stoves must be vented ONLY to the outside, not to other rooms or buildings.
2. Only 8", listed, factory-built, low heat chimney systems with a spark arrester may be used. NOTE: Only chimney systems that were tested for use with this stove may be employed. SEE APPROVED PIPE SYSTEMS.
3. NEVER vent your woodburning stove into a "Class B" gas vent chimney. Check with local authorities to make sure that you are not doing so inadvertently if you are using an existing chimney.
4. No single wall vent or connector may be used.
5. THIS WOODSTOVE SHOULD NOT BE INSTALLED IN A SLEEPING ROOM!
6. Locate the area where the stove is desired. Determine where the ceiling and floor joists are and position the stove so that the chimney penetration will be between ceiling joists and will not interfere with plumbing or electrical wiring.

Building Codes and Permits

Some areas may require a permit from the city, county, Building Inspector or Fire Marshal. Check local building codes before beginning installation. After the installation is completed, it should be checked by your local Fire Marshal or Building Inspector before use.

Selection of Stove Location

The International Conference of Building Officials will recognize this appliance only if it is connected to an 8", listed, prefabricated, low heat chimney as tested with the stove and minimum clearances to combustibles are observed.

When deciding exactly where to position your stove, consider that you will want to place the stove as near as practicable to the center of your home for maximum heat efficiency. Hot air rises, so a layer of warm air will form along the ceiling and spread outward and upward to other areas of the house.

Moreover, the actual placement of your stove must take into careful consideration such factors as the areas through which the pipe venting will occur, including the presence of electrical wiring, plumbing, ceiling joists, rafters, and the position of suitably strong floor joists; as well as the pattern of foot traffic through the room.

WARNING: DO NOT cut ceiling joists or rafters.

DO check floor joists for proper support of your stove.

It is important to remember that in order for your Blaze King[®] woodstove to make the most efficient use of both its radiant heating and/or convective heating capabilities, furniture must be kept well away from your stove. Radiant heat from the stove will strike nearby objects and go no further, creating a "hot spot" in your room, wherein the objects themselves and not the room are warmed. Moreover, the close proximity of furniture and other such combustible objects to your stove may constitute a fire hazard.

Radiant and Convective Heat

All woodburning units use radiant heat—the heat that radiates from a warm object in all directions (like light from a bulb) and strikes objects in its path, warming them. Like light, when radiant heat is stopped by an object, it will go no further. A "shadow" of cold then develops behind objects that have stopped the radiant heat. With the patented Jet-Air design, Blaze King[®] woodstoves have added convective heat to the radiant heat already present.

Air moves upward when it is warmed and downward when cooled. This air movement helps to spread warmth throughout the home. In the Jet-Air models of Blaze King[®] woodstoves, cool air is drawn from near floor level, warmed as it passes through the heat exchanger manifolds inside the firebox, and passes through the side ceramic decoration into the room. This convection heating distributes the heat to all areas more efficiently.

Placement

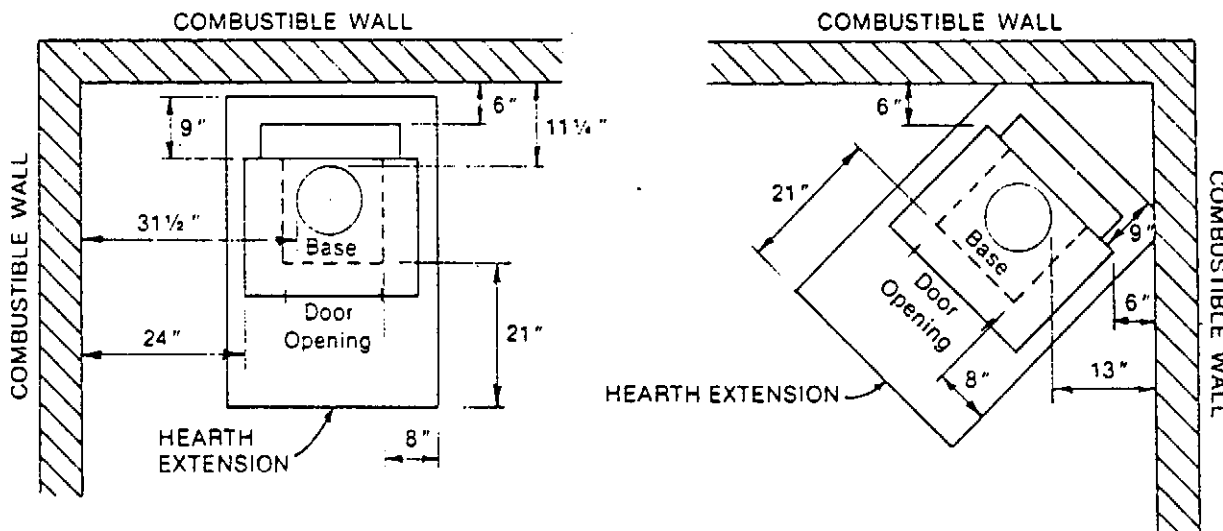

FIG. 4

NOTE: MINIMUM dimensions for the HEARTH EXTENSION must be 1/2" x 45" x 32" non-combustible material.

All hearth clearance dimensions are measured from the stove base. These dimensions provide the proper clearance from the door opening.

Floor and Wall Protection

Consideration must be made for following your local building codes regarding necessary air spaces between non-combustible and combustible materials when installing your stove. **THESE AIR SPACES CANNOT BE IGNORED.** Since sufficient air space constitutes one of the best forms of insulation in the installation of woodburning units, the safety of your home and family will depend largely on how well the local ordinances regarding such air spaces are followed.

The floor area below the stove must be protected with a hearth extension of $\frac{1}{2}$ " minimum thickness non-combustible material, extending at least 8" beyond each side and 21" in front of the stove base. See figure 4.

Chimneys

These freestanding woodstoves can only be vented into "Class A," factory built, prefabricated chimneys, (listed by Underwriters Laboratories, Inc. or other approved laboratories) tested for use with this stove and installed through the ceiling.

Under no conditions may more than one woodburning appliance be connected to one chimney. A proper chimney is most important for safe, satisfactory operation of any wood heating system.

Generally, the taller the chimney, the stronger and more dependable the draft. The chimney should also be kept warm to enhance the draft and protect against condensation of water vapor and smoke, which creates creosote. A build-up of creosote can reduce the draft and will become a potential fire hazard.

A chimney should extend at least three feet above a flat roof, or at least two feet above any part of the roof within 10 feet. Chimney tops should NEVER be near trees or other tall objects that might cause down-drafts.

There are two major types of stove pipe—insulated and not insulated. Insulated pipe (Class A) is actually pre-fabricated chimney. Only listed 8" insulated pipe which was tested with the stove is approved for installation with these models. **SEE APPROVED PIPE SYSTEMS.**

The smoke collar accepts only 8" insulated pipe. The crimped end of the pipe fits into the collar to enable any distillates which may form in the chimney to fall back into the stove.

Outside Air Supply

For proper installation, it is not mandatory that outside air for combustion be used. However, if local codes require it, an **OUTSIDE AIR KIT** is available from the dealer who sold you the stove.

The outside air inlet hose is a flexible tube which can be bent to take outside air in through the wall or up through the floor. The flexible tube will allow some adjustment over or around floor joists or plumbing. **DO NOT CHANGE THE STRUCTURAL INTEGRITY OF THE FLOOR.** This air hose must be kept open at all times to provide outside air for combustion.

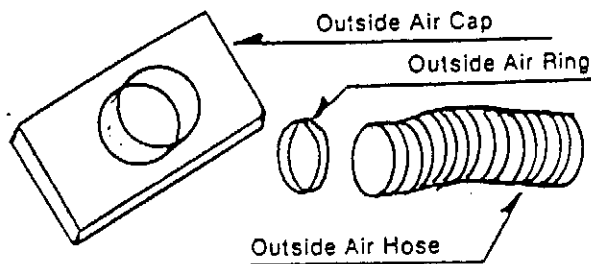

FIG. 5

APPROVED PIPE SYSTEMS FOR PF-202 and PFJ-202

METAL BESTOS

8S-CT	Round Top
8S-SA	Spark Arrester Cap
8S-SC	Storm Collar
8S-AF	Roof Flashing
8S-*	Chimney Pipe
8S-TC	Trim Collar
8S-JS	Joist Shield
WCJS-2909	Joist Shield (alternate to 8S-JS above)

DURA-VENT (Kit A)

5278	(8DCR-C) Spark Arrester Cap
5259	(8DCR-SC) Storm Collar
5249	(8DCR-RFS) Flashing
5221	(8DCR-P) Triple Wall Pipe
5247	(8DC-SA) Support Assembly
5263-A	Joist Shield
5253	Roof Rafter Shield

DURA-VENT (Kit B)

8879	(8DVL-CWD) 1 section with damper
8880	(8DVL-C) 1 section without damper (optional)
8824	(8DVL-P) Pipe (double wall)
5248B	(8DCR-S) Ceiling Support Box—24"

SECURITY CHIMNEY LTD.

8CPE	Spark Arrester Cap
8FA	Adjustable Roof Flashing (includes storm collar)
8L	Chimney
8RS	Radiation Shield
WCJS2909	Joist Shield (alternate to 8RS above)

TRI-STAK

8W-CA	Spark Arrester Cap
8W-SC	Storm Collar
8W-RF	Flashing
8W-TC	Trim Collar
8W	Pipe-*
8W-JS	Joist Shield
WCJS2909	Joist Shield (alternate to 8W-JS Joist Shield above)

1 each with the following exception
*lengths as required—See your dealer

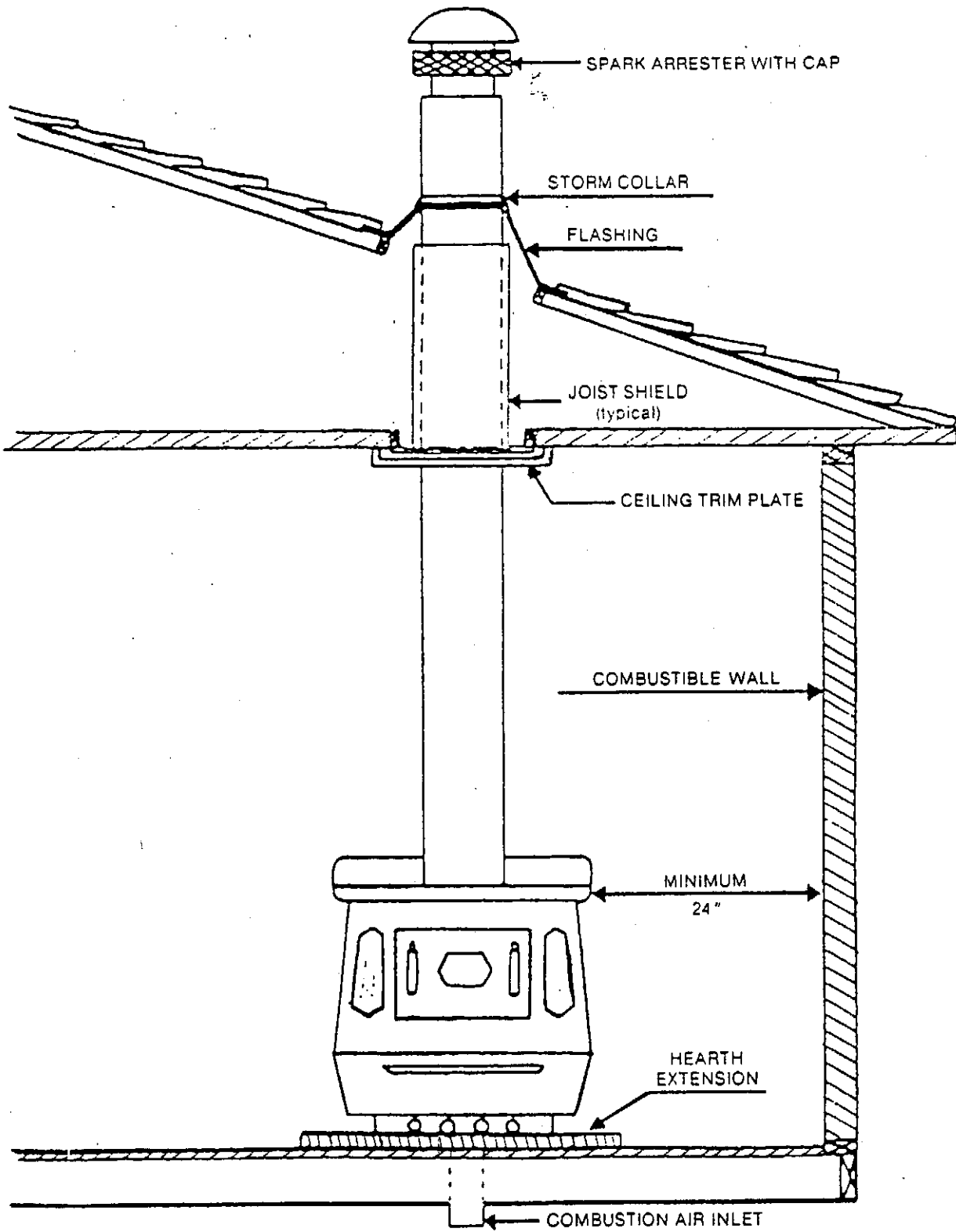

FIG. 6

Installation

1. Set hearth and stove in location for marking holes in accordance with the dimensions listed on Fig. 4 and 6.
2. Mark the position for the hole in the ceiling and roof by using a string and plumb-bob.
3. Check that the intended location will not interfere with floor joists, ceiling joists, or rafters before proceeding further.
4. (if required) Mark the position of the hole for the Outside Air Hose.
5. (if required) Move the stove. Using a saber saw with a masonry blade, cut a 2- $\frac{3}{4}$ " hole for the Outside Air Hose.
6. Cut a pilot hole in ceiling.
7. Cut a 14 $\frac{1}{2}$ " square hole and frame in both sides of this hole in both ceiling and roof (FOR SAFE INSTALLATION HOLE MUST NOT BE SMALLER THAN 14 $\frac{1}{2}$ ").
8. Measure the distance from the ceiling to the top of any combustible material. If required, trim the top of the joist shield so that it will clear any combustible material when installed in step 13. Note that the joist shield may extend completely through the roof on some installations and may require trimming only to allow the proper positioning and attachment of the roof flashing and storm collar. See Fig. 6.
9. Slide the stove back into position, engaging the raised lip on the front tie down.
10. Mark the position for the back tie downs. Slide stove forward, drill pilot holes and slide stove back into position, engaging front tie down.
11. Install the remaining two tie downs with the raised lip over the inside back edge of the stove base.
12. To start installing pipe, place the first section of pipe over the stove flue so that the inner pipe slips inside of the flue collar.
13. Install the remaining lengths of insulated pipe one on top of the other to the finished height of the chimney connector, and secure to each other. When approaching the ceiling, slip the ceiling trim plate and joist shield over the chimney so that after the chimney is extended through the ceiling, the ceiling trim plate can be secured to the ceiling. The joist shield rests on the ceiling trim plate but is not secured to it. CAUTION: Since the chimney section lengths vary, you will need to calculate where the joints will come to ensure that they do not come between the ceiling and roof.
14. Slip the roof flashing down over the chimney and nail to the roof, being careful to keep the pipe centered in the opening. NOTE: To meet the code, the chimney must extend above the roof at least three feet and two feet above any area of the roof within ten feet of the chimney.
15. (if required) Attach the Outside Air Cap to the bottom of the Air Intake Tube by snapping it into place. Install the Outside Air Hose down through the hole cut in step 5. Place the Outside Air Ring over the top end of the Outside Air Hose and install the hose to the Outside Air Cap. Tighten the Outside Air Ring.
16. Install the side ceramics by holding each carefully in place within the raised outline. Gently fold the tabs on the stove face around the ceramic tiles. Do the same with the door ceramic. REMEMBER—these ceramics are a clay product and must be handled carefully. THEY ARE FRAGILE.
17. On Jet-Air models, attach the blower motor. This motor is attached to the blower intake on the rear of the stove with four self-tapping screws. It is equipped with a three-prong (grounded) plug to prevent shock hazard. THIS PLUG SHOULD BE INSERTED DIRECTLY INTO A PROPERLY GROUNDED, THREE-PRONGED RECEPTACLE. DO NOT CUT OR REMOVE THE GROUNDING PRONG FROM THIS PLUG.

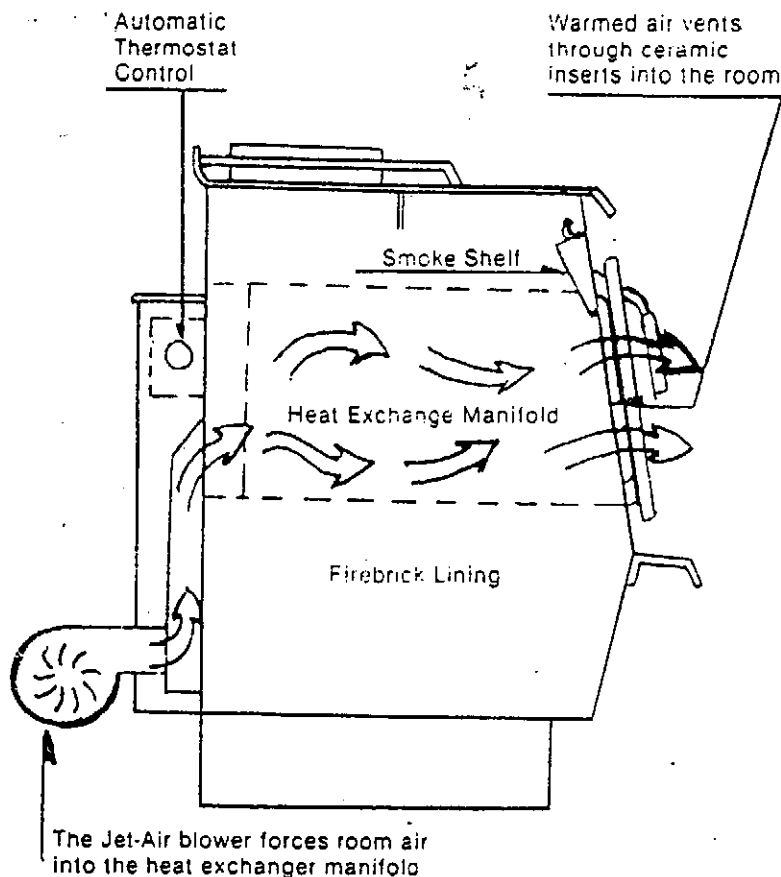

FIG. 7

Fuel

Blaze King[®] woodstoves will burn just about anything. Therefore, it is tempting to burn materials which are inadvisable. Green softwoods burn slowly and with smoke. The soot and moist tar from this smoke sticks to the inside of the chimney. Moisture in green wood will release a great amount of vapor which will condense on the inside of the chimney. The use of dry wood will retard any excessive build up.

Do not burn trash, paper, pine branches or artificial fire logs. Such abuse may void the warranty.

Flammable Liquids

NEVER use gasoline, gasoline-type lantern fuel, kerosene, charcoal lighter fluid, or similar liquids to start or "freshen up" a fire in this stove. Keep all such liquids well away from the stove while it is in use.

THIS STOVE IS FOR USE WITH WOOD AND CHARCOAL ONLY.

The First Fire

Set the thermostat to HIGH (fully counterclockwise).

Place two or three large balls of crumpled paper in the front of the firebox. Lay some small dry sticks or wood chips on top of the paper as kindling. Use enough to establish a good fire base. Lay one or two larger pieces of wood (small logs) on top of the kindling. Light the paper and allow the fire to get a good start.

Now open the door and carefully add three or four good sized logs. More can be added if desired without increasing the heat output—the fire will just burn longer. Close the door tightly and set the thermostat to low (clockwise).

On the Jet-Air model, turn on the fan if desired.

NOTE: As you heat up the stove for the first time, the paint will go through a curing process and it will give off an odor. To minimize this inconvenience, burn the stove at a low temperature setting for several hours. If the odor gets too unpleasant, you may have to open a door or window slightly until the odor dissipates.

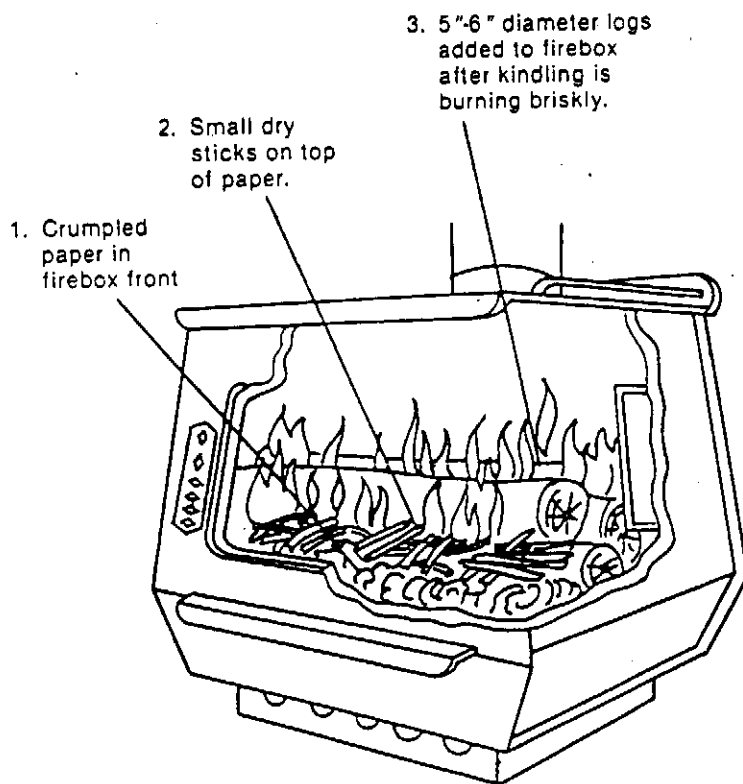

Probably the least understood requirement in maintaining a good fire is that of establishing a good base of ash and coals. Many woodstove users hesitate to load enough wood to sustain a fire, but a good bed of hot coals will maintain a more even temperature as well as getting the new load of wood started easily.

FIG. 8

Operation

When you add fuel to the stove, open the door slightly (about 1") and then hold in that position for 10-30 seconds or until the fire livens up. Then open the door the rest of the way.

Seven or eight 5" or 6" diameter logs may burn for up to 14 hours. This will vary considerably with the variables of model of stove, type of wood, whether the wood is "seasoned," the thermostat setting, the position of the stove in the house, and how well the house is insulated. The stove can be fully loaded without increasing the heat output. The fire will simply burn longer.

CAUTION: After the fire has been allowed to liven up and the door closed, DO NOT open the door for at least 4-5 minutes. Hot gasses build up right after the door is closed and the addition of oxygen when the door opens will cause a rapid combustion, sending smoke and possibly some flame, into the room.

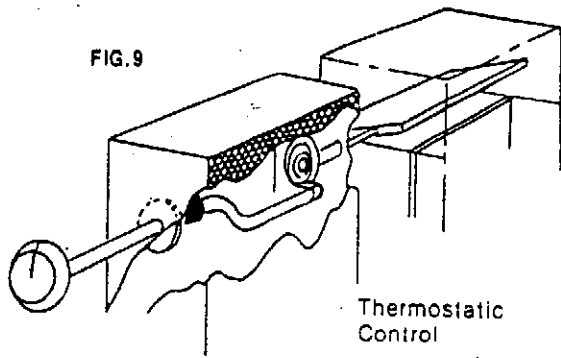

FIG. 9

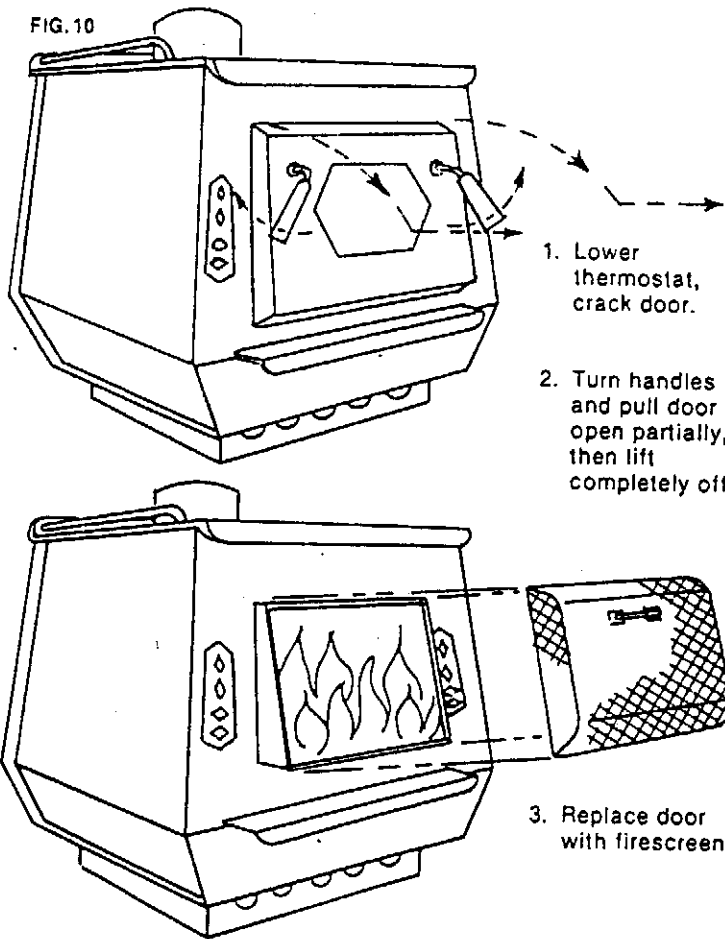

FIG. 10

Under normal operations, the thermostat would be set on low (clockwise), and at this setting the stove is capable of heating an average size home. The thermostat is set at the factory and should not be tampered with. You may notice that the damper in the air intake duct is open even when set on low. This is normal. It will close down automatically after the fire is started.

If at some time it seems that the stove is not getting hot enough for the corresponding draft setting, check to see that something is not blocking the draft inlet inside the stove such as ashes or a piece of wood.

If the thermostat breaks, the damper will automatically close, thus preventing a runaway fire.

To convert the stove to an open fire, first turn the thermostat to LOW. Open the door slightly (about 1") and then hold in that position for 10-30 seconds or until the fire livens up. Next remove the door (open to the vertical position and lift straight up) and replace it with the door screen. "CAUTION": Place the door on a non-combustible surface—it is very hot.

The door with the glass window is installed the same way as the regular door. Set the hinge rods in the hinges with the door in the vertical position. Open or close as desired.

The basic design of the door will keep the glass from becoming clouded rapidly. However, after some amount of use the glass will have to be cleaned. After the door has been removed and allowed to cool, it can be cleaned with soap and water or a non-abrasive cleanser.

If the glass gets broken, your Blaze King® dealer can provide a replacement. After the door has been removed and allowed to cool, remove the screws and the retaining strips on the inside of the door. Retain these parts. Remove the broken glass. Install the braided gasket to the lower edge of the glass. Remove the adhesive backing and with the gasket centered over the edge of the glass, fold the gasket so that it adheres to both sides of the lower edge of the glass. Insert the gasketed lower edge into the bottom channel. Attach the top retainer with the screws previously removed. Attach the right and left glass retainers as above.

Lubrication

Lubricate the fan motor bearings of the Jet-Air model every six months with 10 to 20 drops of SAE 10W or SAE 20W non-detergent oil (ML-type) or with electric motor oil.

CAUTION: Do not over-lubricate. The excess oil may damage the windings or electrical wiring on the motor.

Paint

If the black finish on the stove ever becomes blemished, you can repaint with high temperature paint available from your dealer. Do not paint the stove while it is hot.

Ash Removal

The ashes must be removed from the stove any time they start getting close to covering the draft inlet in the stove firebox. The frequency with which you need to empty the ashes depends on the type of fuel being used. Remove ashes only when they are cold so the hot coals are not dumped where they may start a fire.

Ashes should be placed in a metal container with a tight-fitting lid. The closed container of ashes should be placed on a noncombustible floor or on the ground, well away from all combustible materials, pending final disposal. If the ashes are disposed of by burial in the soil or otherwise locally dispersed, they should be retained in the closed container until thoroughly cooled.

Creosote—Formation and Need for Removal

When wood is burned slowly, it produces tar and other organic vapors, which combine with expelled moisture to form creosote. The creosote vapors condense in the relatively cool chimney flue of a slow-burning fire. As a result, creosote residue accumulates on the flue lining. When ignited, this creosote makes an extremely hot fire. The chimney connector and chimney should be inspected at least twice monthly during the heating season to determine if a creosote buildup has occurred.

If creosote has accumulated, it should be removed to reduce the risk of a chimney fire.

Further Information

For further information on using your wood stove safely, obtain a copy of the National Fire Protection Association publication, "Using Coal and Woodstoves Safely," NFPA #HS-10. The address is:

National Fire Protection Association
Batterymarch Park
Quincy, MA 02269

Authorized Service Representative

Your local Blaze King[®] dealer is your authorized service representative. Should you have any problems with operation or maintenance of your stove, contact him as soon as possible. He will assist you in resolving any operation problems, provide replacement parts, and/or arrange warranty repairs as required. He will need information such as model, serial number, date of purchase and a summary of the problem to accomplish the resolution of your problem. A list of some of the more common replacement parts is shown on the following page.

REPLACEMENT PARTS

Item	Part No.	
CERAMICS		
Blaze Princess	0116	orange, brown, blue, green, black
Blaze Princess, Jet-Air	0117	orange, brown, blue, green, black
DOOR GASKET	0180	
DOOR HANDLES	0118	
DOOR SCREEN		
MOTOR	0112	
SPRAY PAINT (Aerosol can)	0128	
THERMOSTAT KNOB	0102	
OUTSIDE AIR KIT		

MANUFACTURED UNDER LICENSEE AGREEMENT

FROM: WOODCUTTERS MFG., INC.
ROUTE 4, BOX 218
WALLA WALLA, WA 99362

BY:

Blaze King[®]

OWNER'S
INSTALLATION AND OPERATION
INSTRUCTION
BOOK

FOR RESIDENTIAL INSTALLATION
BLAZE PRINCESS, TOP VENT
PF-202 and PFJ-202