

Sirocco 25 Ashford 25 & Princess Inserts Specifications & Features

Sirocco 25, Ashford 25 & Princess Inserts

Clearances to Combustibles	Sirocco 25	Ashford 25	Princess
A - Door Opening to side wall	13½"	13½"	7"
B - Top of door opening to mantle	38" (24" w/shield)	38" (24" w/shield)	22"
C - Side of unit to combustible facing	10"	10"	7"
Floor Protection			
D - Side floor protection to firebox opening	8"†	8"†	8"
E - Front floor protection to firebox opening – US	16"*	16"	16"
Canada	18"*	18"	18"
F - Mantle width maximum	12"	12"	-
G - Back of surround to firebox opening	2.7"	2.7"	10 ⁵ / ₈ "
Minimum Fireplace Opening (Width x Height x Depth)	28" x 21¾" x 18½"	28" x 21¾" x 18½"	25" x 23½" x 13"

† Measured from each side of the fuel loading and ash removal openings.
 * If unit is installed on a hearth flush with a combustible surface, then R1.1 protection is required 19" in front of the door opening and 8" on the unit sides. If the unit is installed on a hearth elevated 3" or more from a combustible surface, then 18" of non-combustible floor protection is required in front of the door opening and 8" on the unit sides.
 Approved for Factory Built & Masonry Fireplaces. If installed in Factory Built Fireplace, fireplace & required liner must meet UL127/UL1777 or ULCS610/ULCS635. For Complete Installation Information refer to Owner's Manual prior to installation.

Sirocco 25, Ashford 25 & Princess Inserts Specifications

Specifications	Sirocco 25	Ashford 25	Princess
Sq. ft. heating capacity	400 to 1,600 sq. ft.	400 to 1,600 sq. ft.	1,000 to 2,300 sq. ft.
Variable Speed Fan	120cfm	120cfm	150cfm
Wood length	22" (recommended 16")	22" (recommended 16")	20" (recommended 16")
Wood capacity (soft wood)	35 lb.	35 lb.	38 lb.
Wood capacity (hard wood)	40 lb.	40 lb.	53 lb.
Flue size	6"	6"	6"
Door opening	25¼" x 10 ⁵ / ₈ "	25¼" x 10 ⁵ / ₈ "	16 ³ / ₈ " x 9"
Firebox depth	16¾" (brick to brick) 18" (brick to glass)	16¾" (brick to brick) 18" (brick to glass)	18" (brick to brick) 20½" (brick to glass)
Firebox width	20½" (front) 18" (rear)	20½" (front) 18" (rear)	21½"
Firebox height	10"	10"	12½"
Firebox capacity	2.3 cu. ft.	2.3 cu. ft.	2.54 cu. ft.
Small Shroud (Height x Width)	27 ¹ / ₈ " x 38 ⁷ / ₈ "**	-	-
Medium Shroud (Height x Width)	29 ¹ / ₈ " x 38 ⁷ / ₈ "**	29¼" x 42¼"	28 ⁵ / ₈ " x 43 ¹ / ₈ "
Large Shroud (Height x Width)	32 ¹ / ₈ " x 38 ⁷ / ₈ "**	32¼" x 44¼"	32 ⁵ / ₈ " x 47 ¹ / ₈ "
Emissions	0.9 grams/hour	0.9 grams/hour	2.0 grams/hour
Maximum heat input*	311,334 BTU's	311,334 BTU's	413,567 BTU's
Heat output on high**	32,379 BTU's/hour for 8 hours	32,379 BTU's/hour for 8 hours	39,519 BTU's/hour for 9 hours
Low burn time°	Up to 25 hours	Up to 25 hours	Up to 27 hours
High burn time°	Up to 8 hours	Up to 8 hours	Up to 9 hours
Approximate weight	325 lbs.	415 lbs.	350 lbs.

* Combined height of shroud top and shroud base

Blaze King reserves the right to make continuous improvements. Information in this brochure may change without notice. Images are shown for artistic purposes. Consult owners manual for clearances and install requirements. E&OE

Clearances

Sirocco 25 / Princess / Ashford 25

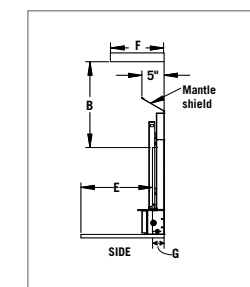
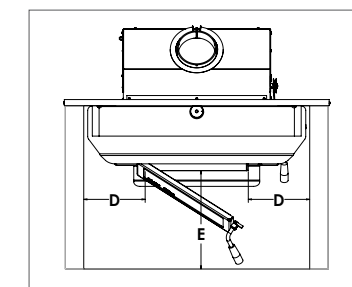
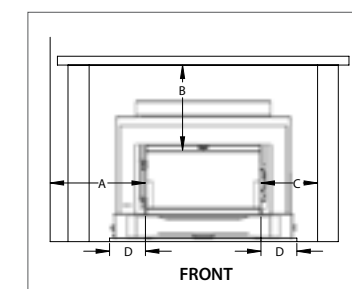

10 Year Extended Warranty

Because we believe in the technology and craftsmanship built into every Blaze King stove we are now pleased to offer a 10 year extended warranty on your catalytic combustor

Dimensions

Sirocco 25

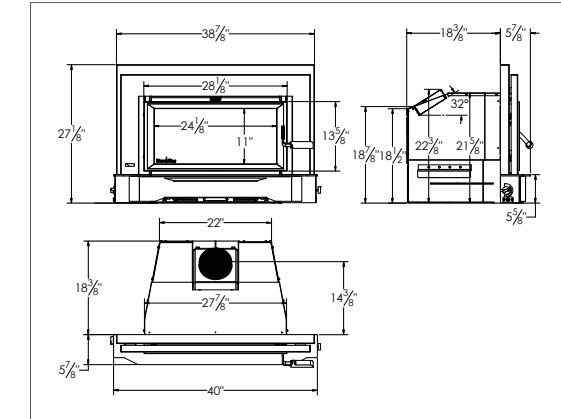

Princess

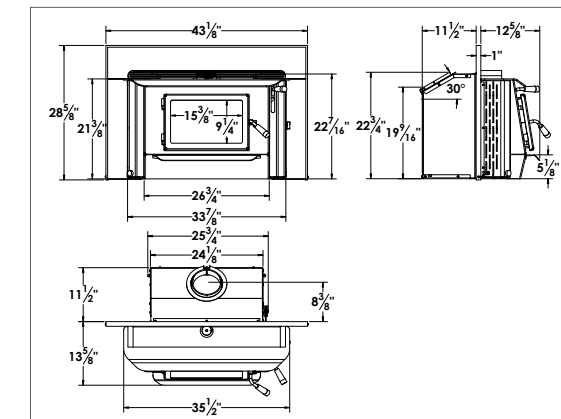

Ashford 25

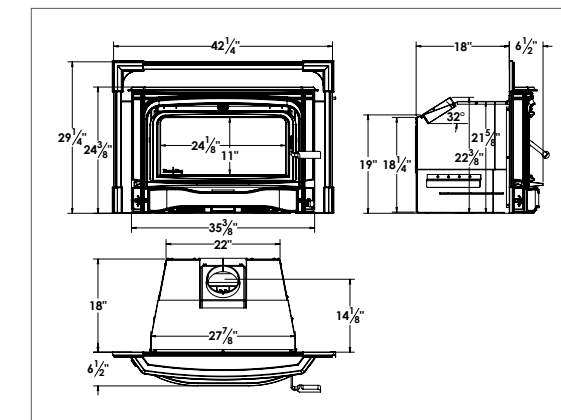

Insert Features and Options

Features and Options	Sirocco 25	Ashford 25	Princess
Dual Variable Speed Fan	S	S	S
Metalic Black Paint	S	S	S
Chestnut Porcelain Enamel	-	0	-
Small Shroud	0	-	-
Medium Shroud	0	0	0
Large Shroud	0	0	0
Mantle Shield	0	0	-
Painted Door	S	S	0
Satin or Gold Plated Door	-	-	0
Black Solid Door	-	-	0
Removable Flue Collar	S	S	-

S - standard feature, 0 - optional feature, - not available

Thermostat Control (No electricity required) All Blaze King inserts come with a built in thermostat that automatically adjusts the air for combustion and allows you to regulate the heat from your stove by up to 70% difference between high and low heat.

Easy to operate Light a fire and simply select the heat setting you require. Your Blaze King will now automatically control the heat until you need to load it again. Which could be up to 27 hours depending on the installation and model etc. The goal is not to achieve 27 hours but to give you that all important overnight burn.

Burn 33% less wood The combination of our exclusive thermostat and catalytic combustor technology makes your Blaze King insert one of the most efficient wood inserts in the world. The proof of this is in our flue temperatures. Non Blaze King inserts have flue temperatures of between 600° F and 900° F while your Blaze King flue temperatures are between 200° F and 300° F. Non Blaze King inserts pump valuable heat up the flue while your Blaze King keeps the heat in your home saving you money. Our highly efficient inserts will burn up to 33% less wood. So you cut, stack, load and clean 33% less wood.

Less Cleaning All Blaze King stove's produce very fine ash because we extract every last drop of energy from the wood. As a result you can go for very long periods before you have to empty your stove.

BLAZE KING

Wood Fireplace Inserts



ASHFORD 25



Ashford 25 Fireplace Insert



Ashford 25 -Chestnut Brown Enamel

PRINCESS

Large Wood Insert It is important that you pick the correct stove size to heat your home. The Princess Insert, at 2.54 cu. ft., has a larger size firebox. Your Princess is capable of heating 800 to 2,300 sq.ft*.

A Deeper Firebox The distance from the door opening to the bottom of the firebox is 6 in., allowing the Princess to hold up to 53 lbs. of wood. Our deep fireboxes hold logs in the firebox better and minimize the need to remove ashes.

Performance The Princess is all about performance. The firebox extends 11" onto the hearth which allows more heat to be radiated into the room. It also means this large insert can fit into smaller fireplace openings.

Specifications: Princess Insert	Optimum Performance (LHV)	Real World Tested Performance (HHV)
Maximum heat input*	413,567 BTU's	413,567 BTU's
Efficiency	86%	80%
Constant Heat output on High**	39,519 BTU's/hour for 9 hours	36,762 BTU's/hour for 9 hours
Constant Heat output on Low***	13,173 BTU's/hour for up to 27 hours	12,254 BTU's/hour for up to 27 hours
Square Feet Heated	1,000 – 2,300	
Maximum Log Size	Up to 20" (recommended 16')	
Burn Time*	Up to 27 hours on low	
Emissions (grams/hour)	2.0 g/hr	
Firebox Size	2.54 cu. ft.	
Flue Size	6"	
CO weighted average	.22%	

* Under laboratory controlled conditions we were able to fit 53lbs. of wood into the Princess firebox (2.54cu. ft.) and achieve up a 27 hour burn time. Based on an EPA recognized equivalent of one pound of non-resinous wood equal to 8,500 BTU's and one pound of resinous wood equal to 9,700 BTU's per pound, giving a weighted average of 9,100 BTU's per pound. (9,100 BTU's per lb. x 53lbs = 486,550 BTU's - 15% moisture content = 413,567 BTU's)
 **LHV 413,567 x 86% efficiency = 355,668 BTU's ÷ 9 hours = 39,519 BTU's. HHV 413,567 x 80% efficiency = 330,854 BTU's ÷ 9 hours = 36,762 BTU's.
 ***LHV 413,567 x 86% efficiency = 355,668 BTU's ÷ 27 hours = 13,173 BTU's. HHV 413,567 x 80% efficiency = 335,668 BTU's ÷ 27 hours = 12,254 BTU's.
 * Heat output, burn times, area heated and BTU's will vary depending on area heated, house insulation, geographical location, venting, wood species, wood moisture content etc.

SIROCCO 25



Sirocco 25 Fireplace Insert

Flush Wood Insert The primary design focus, of the Sirocco and Ashford 25, is to deliver an insert with a very large glass area yet fit into smaller fireplaces. These flush inserts extends only 2.6 inches from the face of your fireplace to the door opening, helping to keep hearth protection to a minimum. They feature large, 24" x 11", wide-screen glass viewing areas with nickel plated and hardwood door handles. Choose between the modern layered styling of the Sirocco 25 or the detailed cast iron curves of the Ashford 25.

Performance At 2.3 cu.ft., the tapered firebox will take up to a 22" log and can deliver overnight warmth on a steady low burn. The Sirocco and Ashford 25's are very clean and efficient. Their performance is balanced to deliver a greater amount of radiant heat through the large glass door. In the real world the most important thing is to get overnight heat. By pushing the boundaries of long burn times, Blaze King is able to deliver that all important full night's sleep and much more.

Specifications: Sirocco / Ashford 25 Insert	Optimum Performance (LHV)	Real World Tested Performance (HHV)
Maximum heat input*	311,334 BTU's	311,334 BTU's
Efficiency	83.2%	77%
Constant Heat output on High**	38,947 BTU's/hr for up to 8 hours	29,966 BTU's/hr for up to 8 hours
Constant Heat output on Low***	10,361 BTU's/hr for up to 25 hours	9,589 BTU's/hr for up to 25 hours
Square Feet Heated	400-1,600	
Maximum Log Size	Up to 22" (16" recommended)	
Burn Time*	Up to 25 hours on low	
Emissions (grams/hour)	0.9 g/hr	
Firebox Size	2.3 cu. ft.	
Flue Size	6"	
CO weighted average	.12%	

*Under laboratory conditions we were able to fit 40lbs. of wood into the Sirocco/Ashford 25 firebox (2.3cu.ft.) and achieve a 25 hour burn time. Based on an EPA recognized equivalent of one pound of non-resinous wood equal to 8,500 BTU's and one pound of resinous wood equal to 9,700 BTU's per pound, giving a weighted average of 9,100 BTU's per pound. (9,100 BTU's per lb. x 40lbs = 366,275 BTU's - 15% moisture content = 311,334 BTU's)
 **LHV 311,334 x 83.2% efficiency = 259,030 BTU's ÷ 8 hours = 32,379 BTU's. HHV 311,334 x 77% efficiency = 239,727 BTU's ÷ 8 hours = 29,966 BTU's.
 ***LHV 311,334 x 83.2% efficiency = 259,030 BTU's ÷ 25 hours = 10,361 BTU's. HHV 311,334 x 77% efficiency = 239,727 BTU's ÷ 25 hours = 9,589 BTU's.
 * Heat output, burn times, area heated and BTU's will vary depending on area heated, house insulation, geographical location, venting, wood species, wood moisture content etc.



Princess Insert with Painted Door